

Silicon Carbide Power MOSFET

Parameter	Value	Unit
V_{DS}	650	V
I_D	36	A
$R_{DS(ON)}$	90	m Ω
Q_G	41	nC

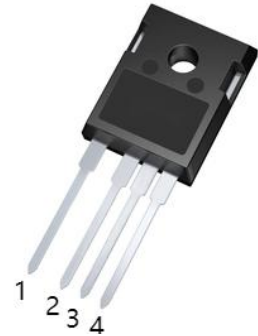
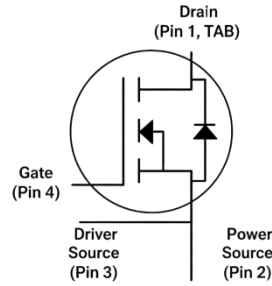

TO-247-4L

Features

- High Speed Switching with Low Capacitances
- High Blocking Voltage with Low $R_{DS(on)}$
- Low impedance package with driver source pin
- Easy to parallel and simple to drive

Applications

- Motor Drives
- Battery Chargers
- Pulsed Power Applications
- High Voltage DC/DC Converters
- Switched-Mode Power Supply(SMPS)

Absolute Maximum Ratings (at $T_J=25^\circ\text{C}$ unless otherwise specified)

Parameter	Symbol	Conditions	Value	Unit
Drain-source Voltage	V_{DS}	$V_{GS}=0V$	650	V
Gate-source Voltage	V_{GS}	Absolute maximum values	-10/+22	V
	V_{GSop}	Recommended operational values	0/+18	
Drain Current (continuous)	I_D	$V_{GS}=15V; T_C=25^\circ\text{C}$	36	A
		$V_{GS}=15V; T_C=100^\circ\text{C}$	27	
Drain Current (pulsed)	I_{DM}	$V_{GS}=15V; T_C=25^\circ\text{C}$	72	A
Power Dissipation	P_D	$T_C=25^\circ\text{C}; T_J=175^\circ\text{C}$	136	W
Operating Junction and Storage Temperature Range	T_J, T_{stg}	-	-55 to +175	$^\circ\text{C}$
Thermal Resistance from Junction to Case	$R_{\theta JC}$	-	1.1	$^\circ\text{C/W}$

Electrical Characteristics

Parameter	Symbol	Conditions	Value			Unit
			Min.	Typ.	Max.	
Static characteristics (at $T_C=25^\circ\text{C}$ unless otherwise specified)						
Drain-Source Breakdown Voltage	$B_{V_{DS}}$	$V_{GS}=0V; I_D=500\mu A$	650	-	-	V
Gate Threshold Voltage	$V_{GS(th)}$	$V_{GS}=V_{DS}; I_{DS}=7.5mA$	2.7	-	4.5	V
Zero Gate Voltage Drain Current	I_{DSS}	$V_{DS}=650V; V_{GS}=0V; T_J=25^\circ\text{C}$	-	-	10	μA
Gate-Body Leakage Current	I_{GSS}	$V_{GS}=18V; V_{DS}=0V$	-	-	250	nA
Static Drain-Source on Resistance	$R_{DS(on)}$	$V_{GS}=15V; I_D=17A$	-	90	120	m Ω
		$V_{GS}=15V; I_D=17A; T_J=175^\circ\text{C}$	-	75	-	
		$V_{GS}=18V; I_D=17A$	-	65	-	
		$V_{GS}=18V; I_D=17A; T_J=175^\circ\text{C}$	-	70	-	
Dynamic characteristics (at $T_C=25^\circ\text{C}$ unless otherwise specified)						
Input Capacitance	C_{iss}	$V_{DS}=500V; f=100KHz; V_{GS}=0V; T_J=25^\circ\text{C}$	-	1040	-	pF
Output Capacitance	C_{oss}		-	96	-	
Reverse Transfer Capacitance	C_{rss}		-	9	-	
Total Gate Charge	Q_G	$V_{DS}=500V; V_{GS}=0/+15V; I_D=17A; T_J=25^\circ\text{C}$	-	41	-	nC
Gate-Source Charge	Q_{GS}		-	10	-	
Gate-Drain Charge	Q_{GD}		-	16	-	
Gate Resistor	R_G	$f=100KHz; V_{AC}=25mV$	-	2.85	-	Ω
Turn-on Delay Time	$t_{d(on)}$	$V_{DS}=500V; V_{GS}=0/+15V; I_D=17A; R_{g(ext)}=2\Omega$	-	19	-	ns
Rise Time	t_r		-	115	-	
Turn-off Delay Time	$t_{d(off)}$		-	31	-	
Fall Time	t_f		-	34	-	

Reverse SiC Diode Characteristics(at $T_J=25^\circ\text{C}$ unless otherwise specified)

Parameter	Symbol	Conditions	Values			Units
			Min.	Typ.	Max.	
Diode Forward Voltage	V_{FSD}	$V_{GS}=0V; I_F=8.5A; T_J=25^\circ\text{C}$	-	3.5	-	V
Continuous Diode Forward Current	I_S	$V_{GS}=0V; T_J=25^\circ\text{C}$	-	36	-	A
Reverse Recovery Time	t_{RR}	$V_R=500V; V_{GS}=0V; I_F=17A; di/dt=550A/\mu s; T_J=25^\circ\text{C}$	-	17.8	-	ns
Reverse Recovery Charge	Q_{RR}		-	63	-	nC
Peak Reverse Recovery Current	I_{RRM}		-	4.9	-	A

Typical Characteristics

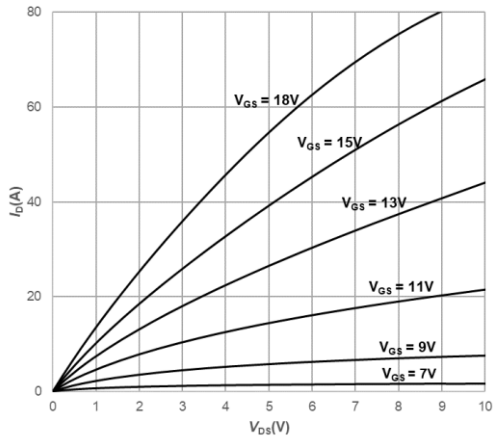

Fig1. Output Characteristics $T_j=25^\circ\text{C}$

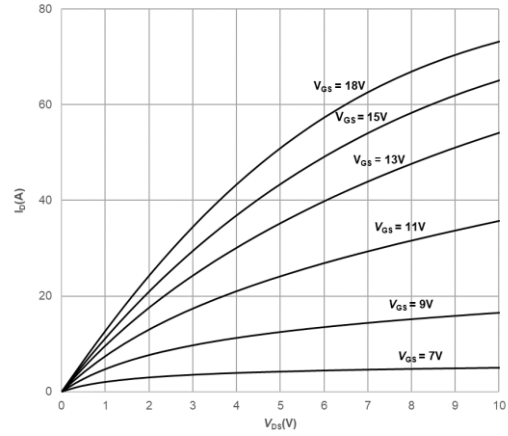

Fig2. Output Characteristics $T_j=175^\circ\text{C}$

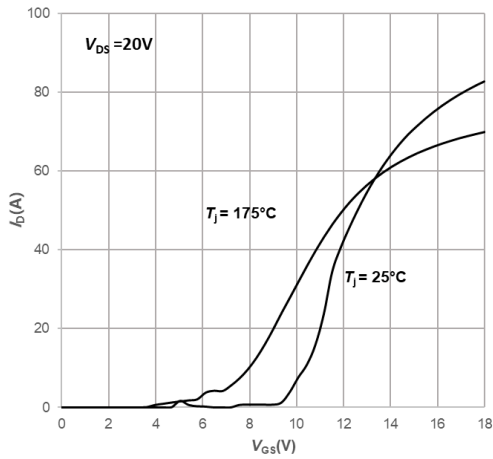

Fig3. Typical Transfer Characteristics

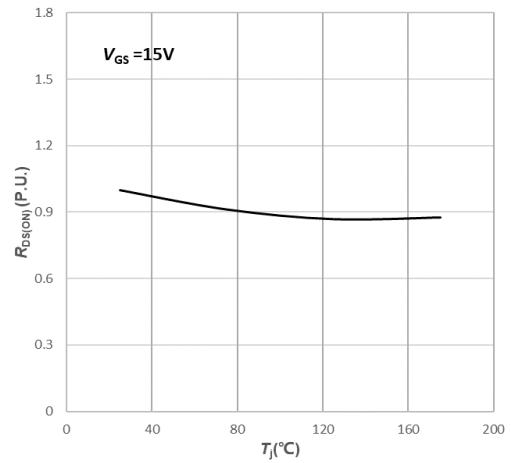

Fig4. Normalized On-Resistance vs. Temperature

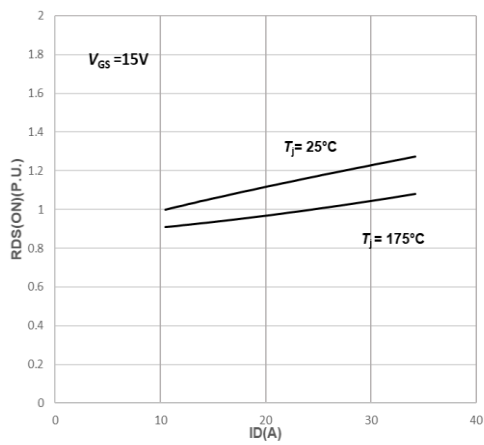

Fig5. Normalized On-Resistance vs. Drain Current For Various Temperatures

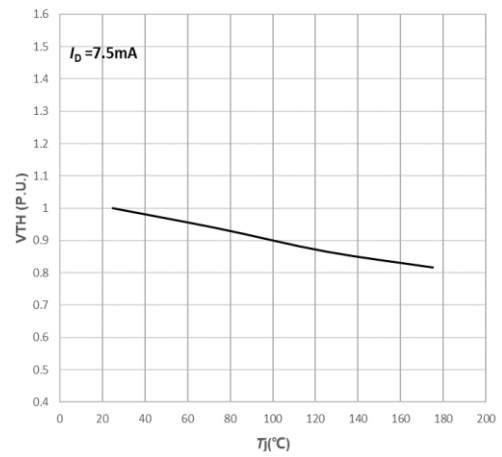

Fig6. Normalized Threshold Voltage vs. Temperature

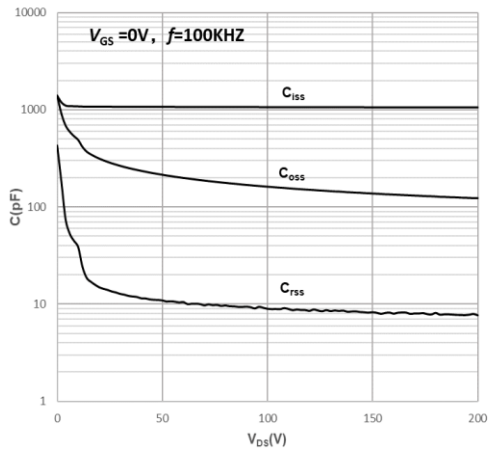

Fig7. Capacitances vs. Drain-Source Voltage (0-200V)

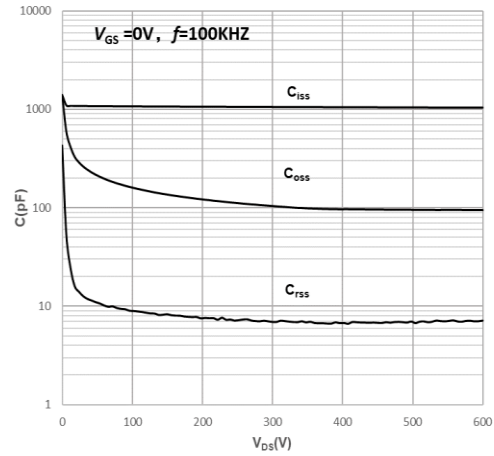

Fig8. Capacitances vs. Drain-Source Voltage (0-600V)

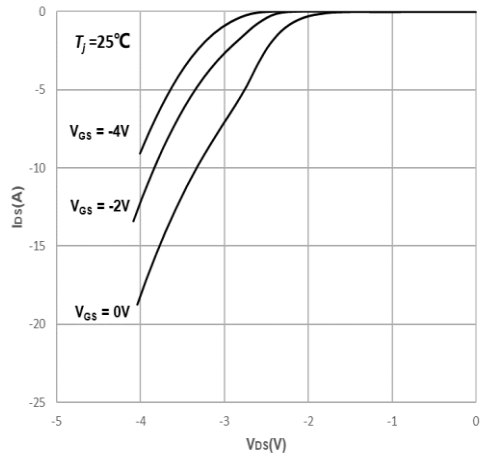
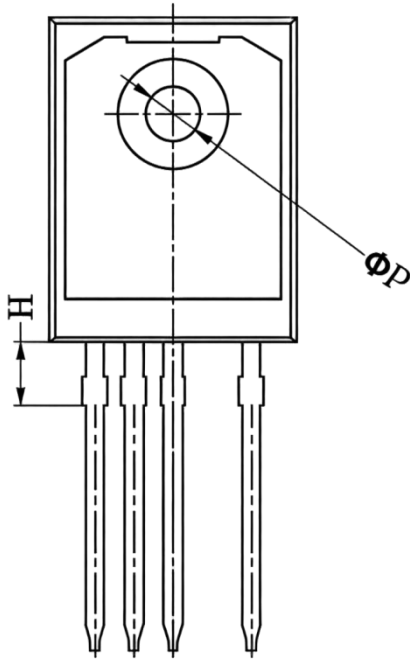
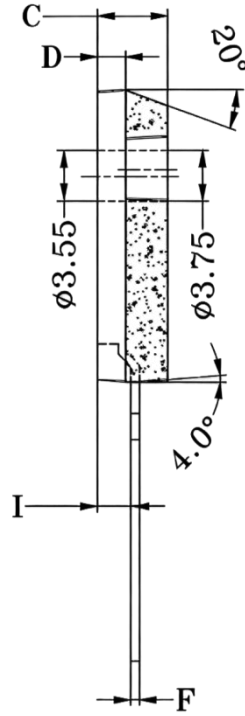
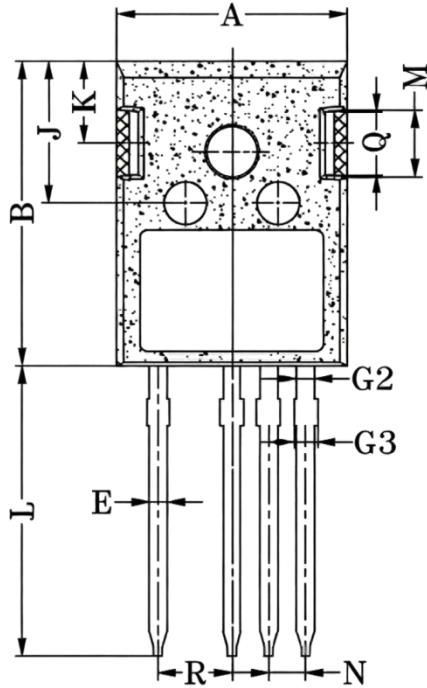

Fig9. Body Diode Characteristics

Package Outlines(Unit:mm)

TO-247-4L



Symbol	Dimensions in Millimeter	
	MIN	MAX
A	15.80	16.00
B	20.90	21.10
C	4.90	5.10
D	1.90	2.10
E	1.10	1.30
F	0.50	0.70
G2	1.10	1.30
G3	1.18	1.38
H	4.18	4.38
I	2.30	2.50
J	9.65	9.85
K	5.54	5.74
L	19.80	20.20
M	4.50	4.70
N	2.34	2.74
ΦP	3.40	3.60
Q	4.232	4.432
R	4.88	5.28

***Important Usage Information and Disclaimer**

The specifications of Zhuhai Hypersemi Co., Ltd. products are not guarantees of product characteristics. They reflect typical performance expected in standard applications, which may vary with specific uses. Users must conduct prior testing for their applications and make necessary adjustments.

Users are responsible for the safety of applications utilizing our products and must implement adequate safety measures to prevent physical injury, fire, or other risks in case of product failure. It is the user's duty to ensure that application designs comply with all applicable laws and standards. Our products must not be used in any applications where a product failure could reasonably result in personal injury, unless specifically authorized in a signed document by Zhuhai Hypersemi Co., Ltd.

No representations or warranties are made regarding the accuracy or completeness of this information, including any claims of non-infringement of third-party intellectual property rights. Zhuhai Hypersemi Co., Ltd. assumes no liability for any applications or uses of its products and does not grant any licenses to its intellectual property rights or those of others. We also make no claims regarding non-infringement of third-party intellectual property rights that may arise from applications.

Due to technical requirements, our products may contain hazardous substances. For details, please contact your nearest sales office. This document replaces all previous information and may be updated. We reserve the right to make changes.