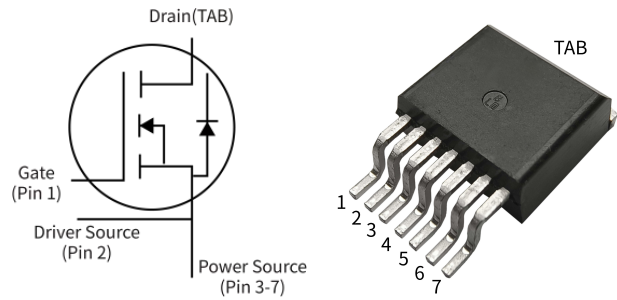


**Silicon Carbide Power MOSFET**

Parameter	Value	Unit
$V_{DS}$	1200	V
$I_D$	20	A
$R_{DS(ON)}$	160	m $\Omega$
$Q_G$	26	nC



TO-263-7L

**Features**

- High Speed Switching with Low Capacitances
- High Blocking Voltage with Low  $R_{DS(on)}$
- Low impedance package with driver source pin
- Easy to parallel and simple to drive

**Applications**

- EV Charging
- High Voltage DC/DC Converters
- Switched-Mode Power Supply(SMPS)
- Power Factor Correction(PFC)

**Absolute Maximum Ratings** (at  $T_J=25^{\circ}C$  unless otherwise specified)

Parameter	Symbol	Value	Unit
Drain-source Voltage	$V_{DS}$	1200	V
Gate-source Voltage	$V_{GS}$	-8/+19	V
Drain Current (continuous; $T_c=25^{\circ}C$ )	$I_D$	20	A
Drain Current (continuous; $T_c=100^{\circ}C$ )		12	
Drain Current (pulsed)	$I_{DM}$	35	A
Power Dissipation ( $T_c=25^{\circ}C$ )	$P_D$	108	W
Operating Junction and Storage Temperature Range	$T_J, T_{stg}$	-55 to +175	$^{\circ}C$
Thermal Resistance from Junction to Case	$R_{\theta JC}$	1.38	$^{\circ}C/W$
Thermal Resistance From Junction to Ambient	$R_{\theta JA}$	40	

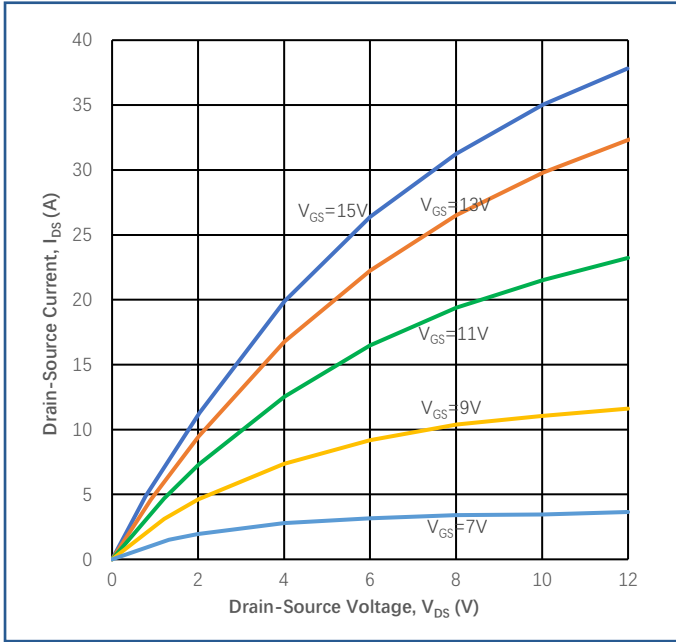
**Electrical Characteristics**

Parameter	Symbol	Conditions	Value			Unit
			Min.	Typ.	Max.	
<b>Static characteristics</b> (at $T_C=25^\circ\text{C}$ unless otherwise specified)						
Drain-Source Breakdown Voltage	$B_{V_{DS}}$	$V_{GS}=0V; I_D=250\mu A$	1200	-	-	V
Zero Gate Voltage Drain Current	$I_{DSS}$	$V_{DS}=1200V; V_{GS}=0V; T_J=25^\circ\text{C}$	-	-	100	$\mu A$
Gate-Body Leakage Current	$I_{GSS}$	$V_{GS}=-8/+19V; V_{DS}=0V$	-	-	250	nA
Gate Threshold Voltage	$V_{GS(th)}$	$V_{GS}=V_{DS}; I_{DS}=2mA$	1.8	2.5	3.6	V
Recommended Turn-on Voltage	$V_{GS(on)}$	Static	-	15	-	V
Recommended Turn-off Voltage	$V_{GS(off)}$		-	-4	-	V
Static Drain-Source on Resistance	$R_{DS(on)}$	$V_{GS}=15V; I_D=10A$	-	160	208	m $\Omega$
		$V_{GS}=15V; I_D=10A; T_J=175^\circ\text{C}$	-	272	-	
<b>Dynamic characteristics</b> (at $T_C=25^\circ\text{C}$ unless otherwise specified)						
Input Capacitance	$C_{iss}$	$V_{DS}=1000V; f=1MHz; V_{AC}=25mV$	-	715	-	pF
Output Capacitance	$C_{oss}$		-	42	-	
Reverse Transfer Capacitance	$C_{rss}$		-	3.2	-	
Transconductance	$g_{fs}$	$V_{DS}=20V; I_D=10A$	-	6	-	S
$C_{OSS}$ Stored Energy	$E_{OSS}$	$V_{DS}=1000V; f=1MHz$	-	23	-	$\mu J$
Turn-on Energy	$E_{on}$	$V_{DS}=800V; V_{GS}=-4/+15V; I_D=10A;$ $Load=300\mu H; T_J=175^\circ\text{C}$	-	105	-	$\mu J$
Turn-off Energy	$E_{off}$		-	17	-	
Total Gate Charge	$Q_G$	$V_{DS}=800V; V_{GS}=-4/+15V; I_D=10A$	-	26	-	nC
Gate-Source Charge	$Q_{GS}$		-	12	-	
Gate-Drain Charge	$Q_{GD}$		-	6	-	
Internal Gate Resistor	$R_{Gint}$	$f=1MHz; V_{AC}=25mV$	-	5	-	$\Omega$
Turn-on Delay Time	$t_{d(on)}$	$V_{DS}=800V; V_{GS}=-4/+15V; I_D=10A;$ $R_{g(ext)}=2.5\Omega; Load=300\mu H$	-	11	-	ns
Rise Time	$t_r$		-	8	-	
Turn-off Delay Time	$t_{d(off)}$		-	14	-	
Fall Time	$t_f$		-	9	-	

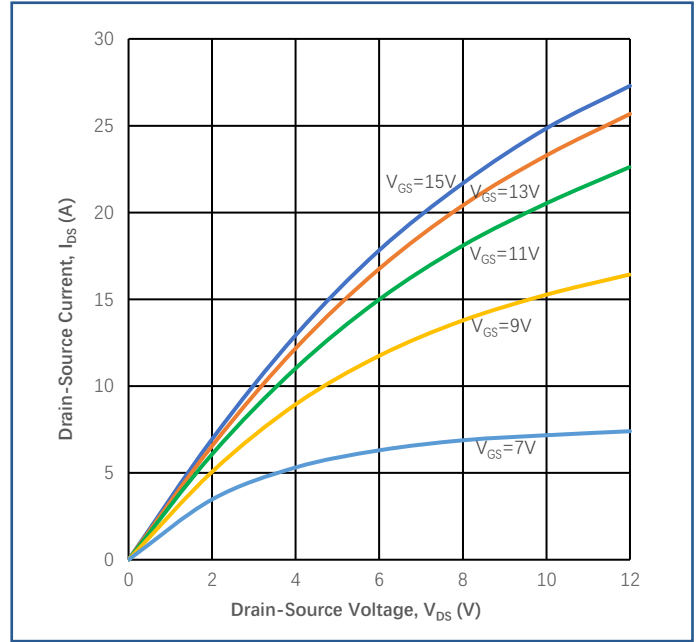
**Reverse SiC Diode Characteristics**(at  $T_J=25^\circ\text{C}$  unless otherwise specified)

Parameter	Symbol	Conditions	Values			Units
			Min.	Typ.	Max.	
Diode Forward Voltage	$V_{FSD}$	$V_{GS}=0V; I_F=5A$	-	3.5	6	V
		$V_{GS}=0V; I_F=5A; T_J=175^\circ\text{C}$	-	3	6	
Continuous Diode Forward Current	$I_S$	$V_{GS}=0V; T_C=25^\circ\text{C}$	-	20	-	A
Reverse Recovery Time	$t_{RR}$	$V_R=800V; V_{GS}=-4V; I_F=10A;$ $di/dt=1900A/\mu s; T_J=175^\circ\text{C}$	-	7	-	ns
Reverse Recovery Charge	$Q_{RR}$		-	33	-	nC
Peak Reverse Recovery Current	$I_{RRM}$		-	9	-	A

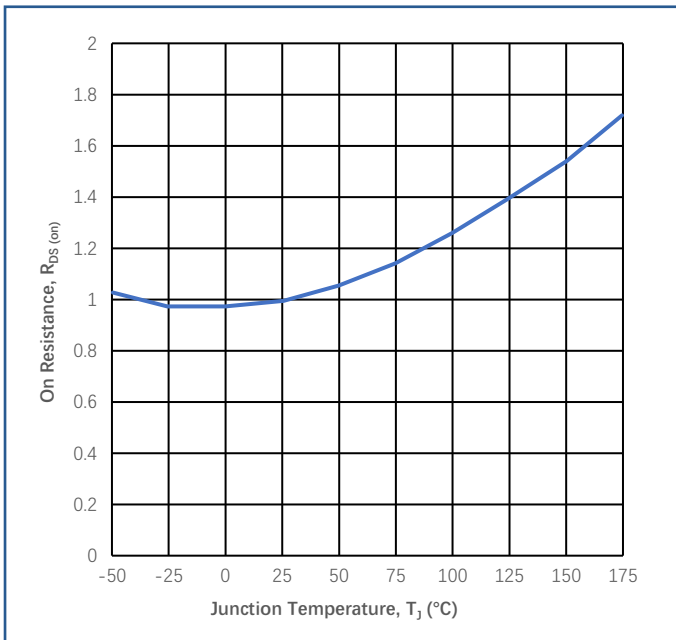
**Typical Characteristics**



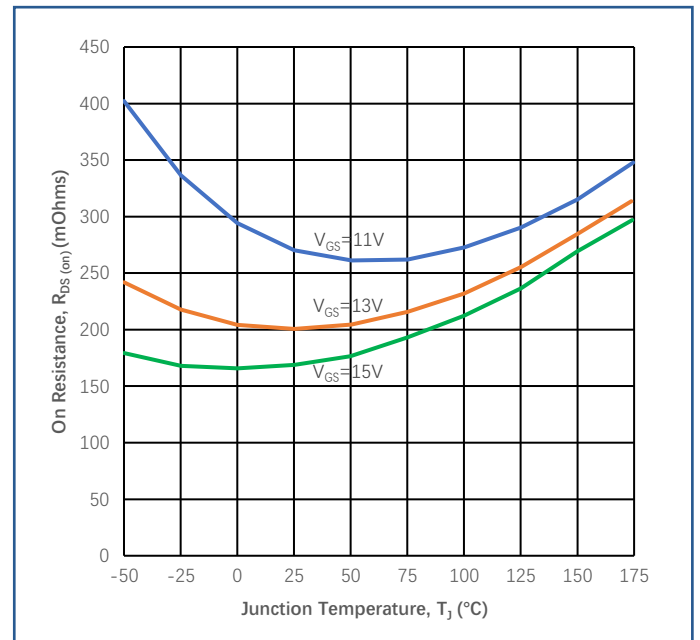
**Fig 1**  
Output Characteristics ( $T_j=25^\circ\text{C}$ )



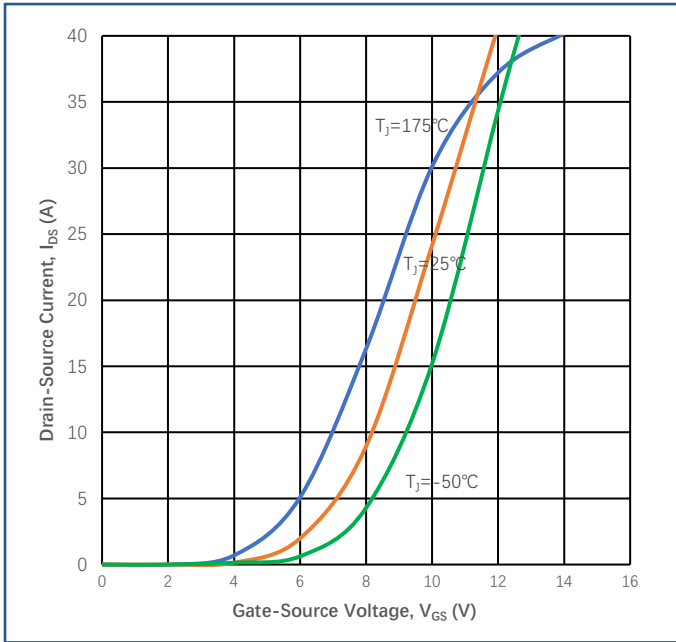
**Fig 2**  
Output Characteristics ( $T_j=175^\circ\text{C}$ )



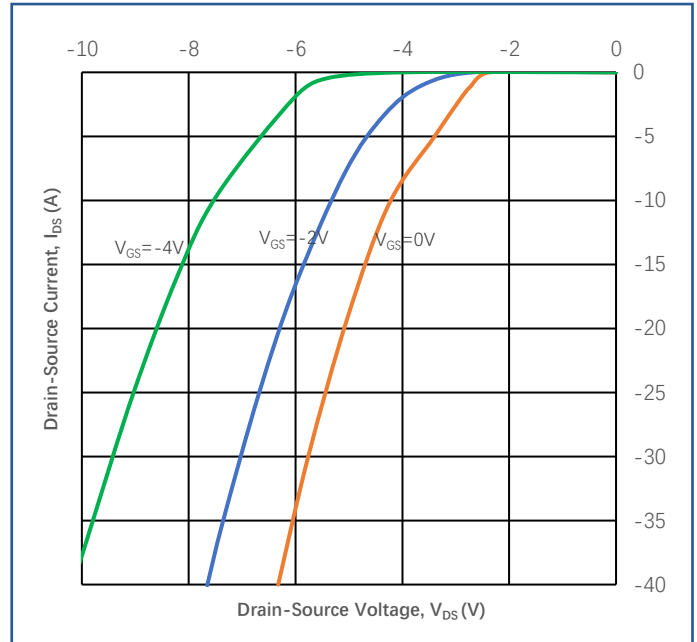
**Fig 3**  
Normalized On-Resistance vs. Temperature



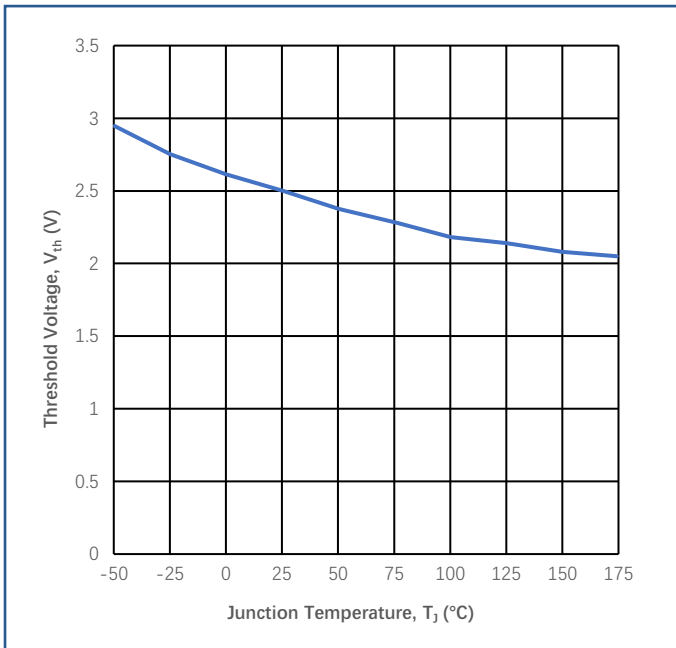
**Fig 4**  
On-Resistance vs. Temperature



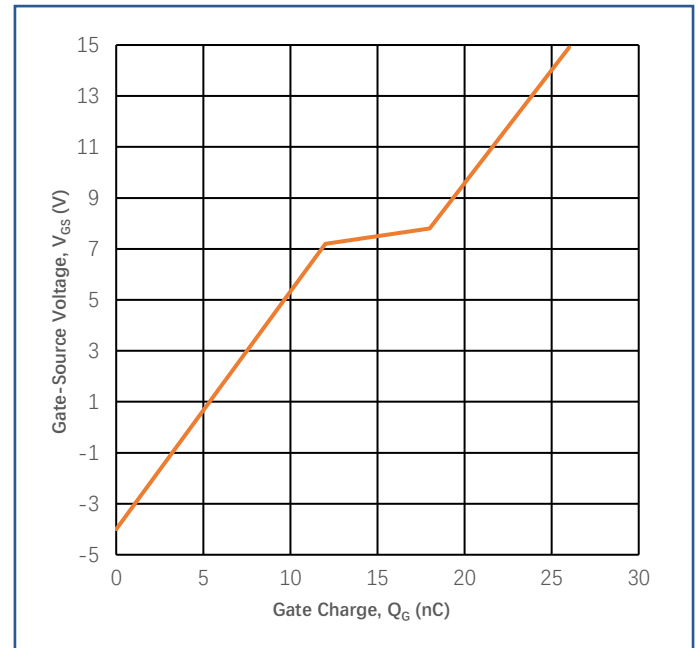
**Fig 5**  
 Transfer Characteristic



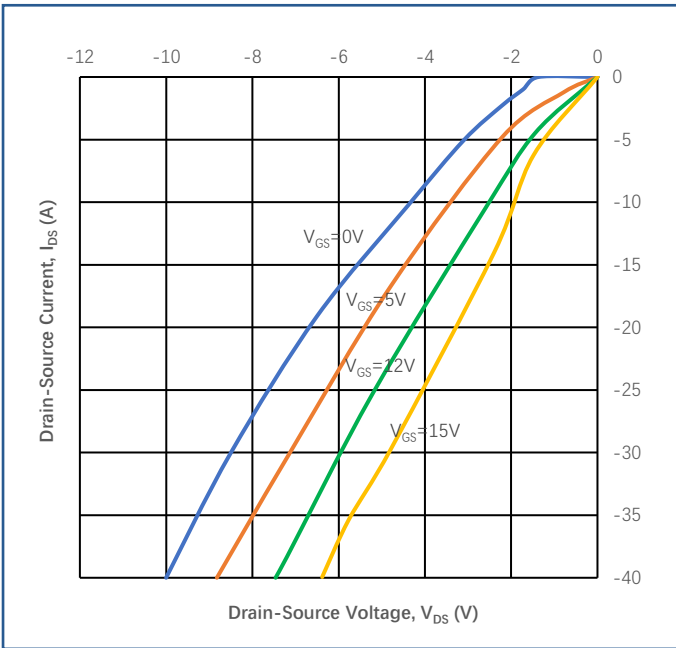
**Fig 6**  
 Body Diode Characteristic at  $25^\circ\text{C}$



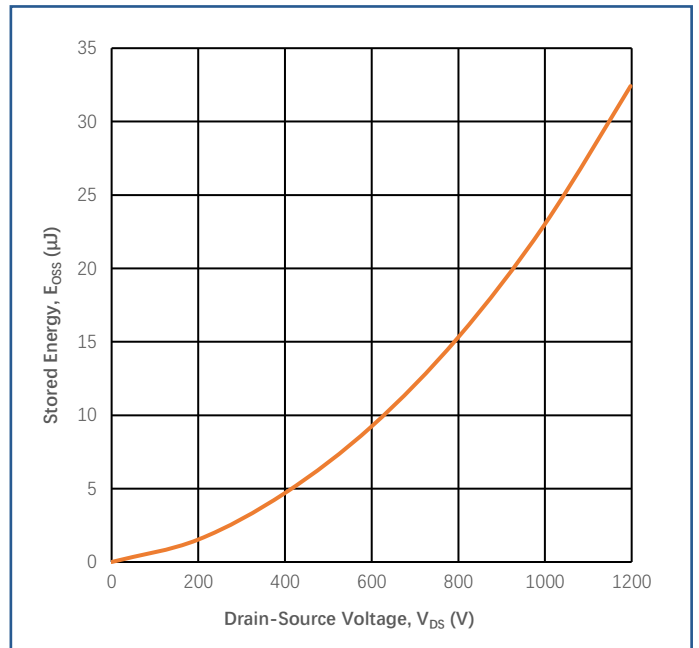
**Fig 7**  
 Threshold Voltage vs. Temperature



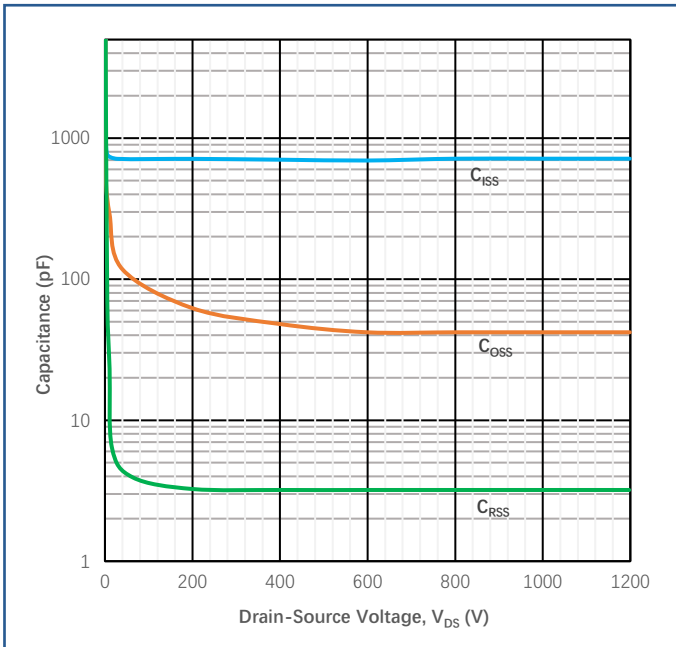
**Fig 8**  
 Gate Charge Characteristics



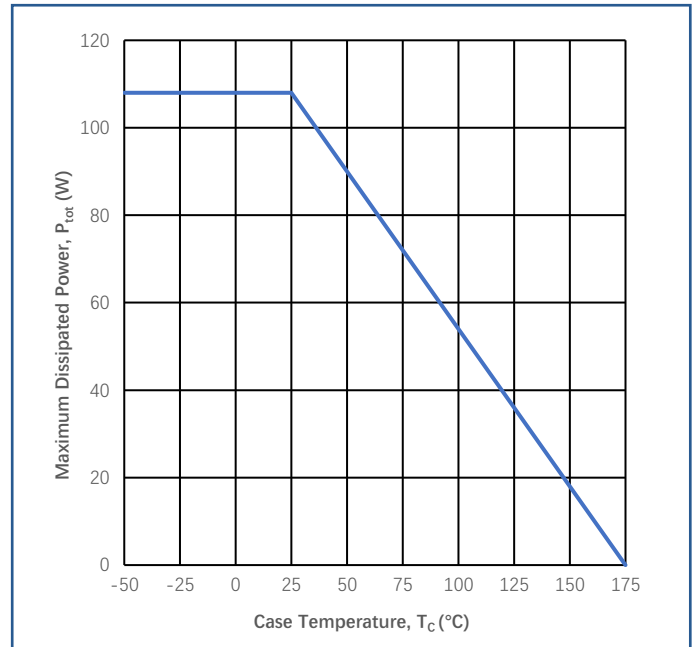
**Fig 9**  
3rd Quadrant Characteristic at 25°C



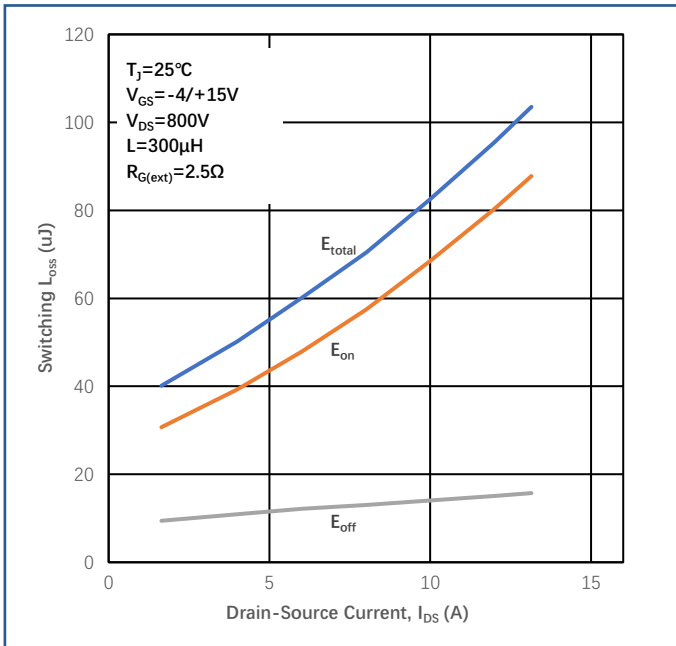
**Fig 10**  
Output Capacitor Stored Energy



**Fig 11**  
Capacitances vs. Drain-Source

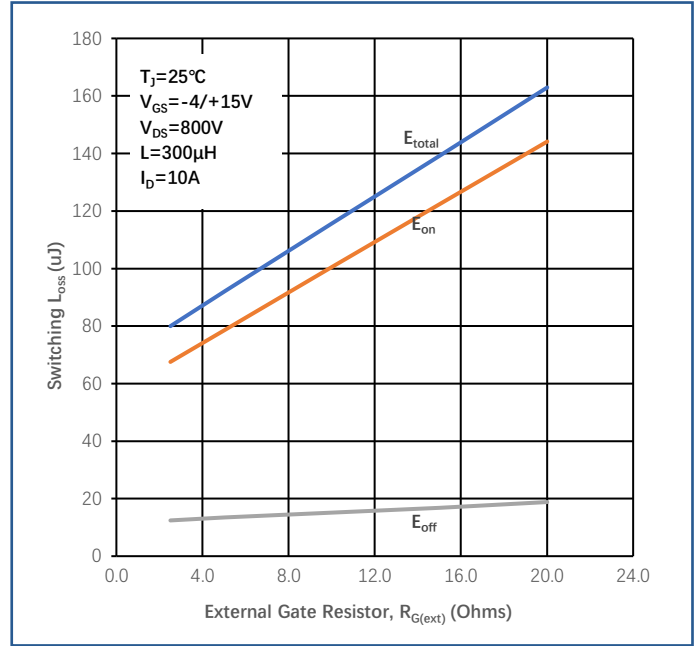


**Fig 12**  
Max Power Dissipation Derating vs  $T_C$



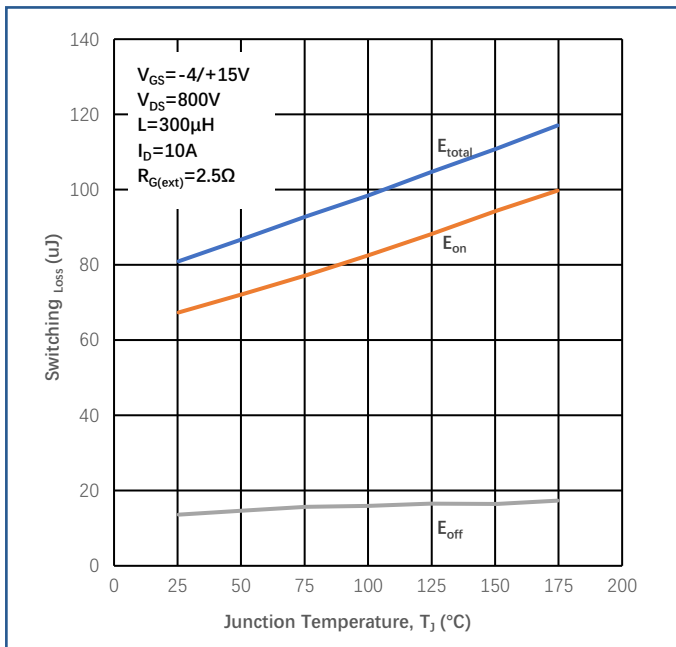
**Fig 13**

Switching Energy vs. Drain Current



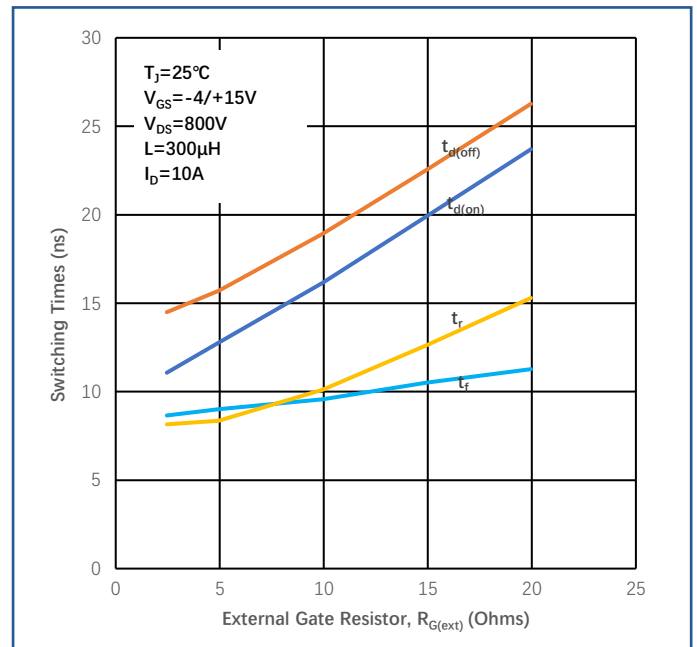
**Fig 14**

Switching Energy vs.  $R_{G(ext)}$



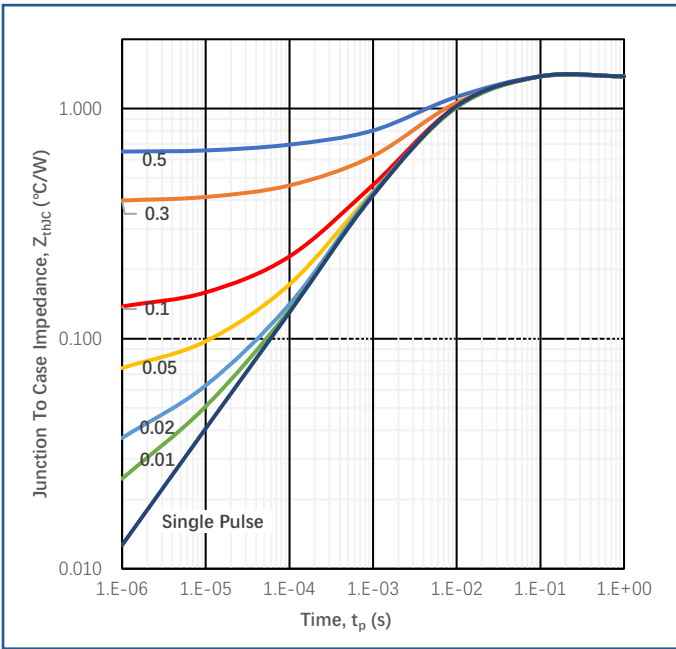
**Fig 15**

Switching Energy vs. Temperature

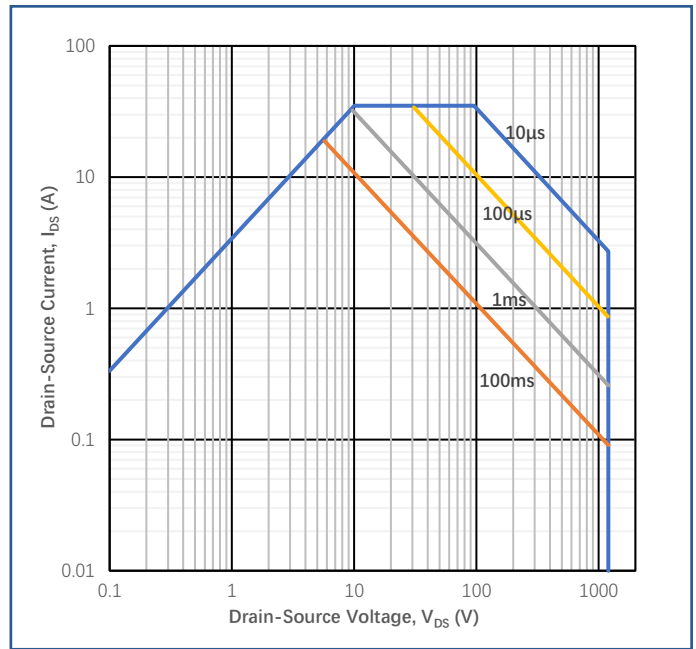


**Fig 16**

Switching Times vs.  $R_{G(ext)}$



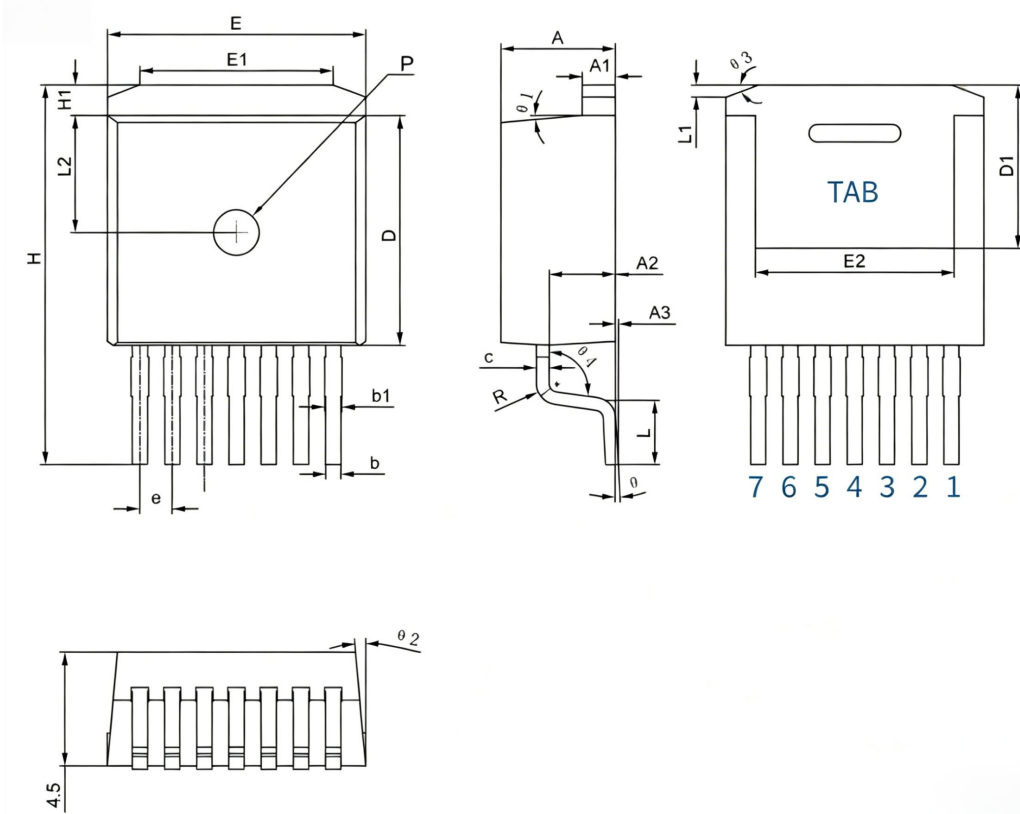
**Fig 17**  
 Transient Thermal Impedance



**Fig 18**  
 Safe Operating Area

**Package Outlines(Unit:mm)**

TO-263-7L



Symbol	Millimeters			Symbol	Millimeters		
	Min.	Type.	Max.		Min.	Type.	Max.
<b>A</b>	4.40	4.50	4.60	<b>e</b>	1.17	1.27	1.37
<b>A1</b>	1.25	1.30	1.40	<b>H</b>	14.75	15.00	15.25
<b>A2</b>	2.45	2.60	2.70	<b>H1</b>	1.10	1.20	1.30
<b>A3</b>	0.05	0.13	0.20	<b>L</b>	2.35	2.55	2.75
<b>b</b>	0.50	0.60	0.70	<b>L1</b>	0.37	0.57	0.77
<b>b1</b>	0.60	0.70	0.85	<b>L2</b>	4.48	4.63	4.78
<b>c</b>	0.45	0.50	0.60	<b>θ</b>	0°	3°	5°
<b>D</b>	8.88	9.08	9.28	<b>θ1</b>	3°	5°	7°
<b>D1</b>	6.25	6.45	6.65	<b>θ2</b>	3°	5°	7°
<b>E</b>	9.88	10.18	10.28	<b>θ3</b>	15°	20°	25°
<b>E1</b>	6.67	7.07	7.47	<b>R</b>	0.75	0.80	0.85
<b>E2</b>	7.67	7.82	7.97	<b>P</b>	1.70	1.80	1.90

Pin	Symbol	Description
1	G	Gate
2	KS	Driver Source
3-7	S	Power Source
TAB	D	Drain

**Note:**

1. All metal surfaces are Sn plated (matte), except area of cut.
2. Burr or mold flash size (0.5 mm) is not included in the dimensions.

**\*Important Usage Information and Disclaimer**

The specifications of Zhuhai Hypersemi Co., Ltd. products are not guarantees of product characteristics. They reflect typical performance expected in standard applications, which may vary with specific uses. Users must conduct prior testing for their applications and make necessary adjustments.

Users are responsible for the safety of applications utilizing our products and must implement adequate safety measures to prevent physical injury, fire, or other risks in case of product failure. It is the user's duty to ensure that application designs comply with all applicable laws and standards. Our products must not be used in any applications where a product failure could reasonably result in personal injury, unless specifically authorized in a signed document by Zhuhai Hypersemi Co., Ltd.

No representations or warranties are made regarding the accuracy or completeness of this information, including any claims of non-infringement of third-party intellectual property rights. Zhuhai Hypersemi Co., Ltd. assumes no liability for any applications or uses of its products and does not grant any licenses to its intellectual property rights or those of others. We also make no claims regarding non-infringement of third-party intellectual property rights that may arise from applications.

Due to technical requirements, our products may contain hazardous substances. For details, please contact your nearest sales office. This document replaces all previous information and may be updated. We reserve the right to make changes.