

Silicon Carbide Schottky Diode

Parameter	Value	Unit
V_{RRM}	1200	V
I_F	8	A
Q_C	38	nC

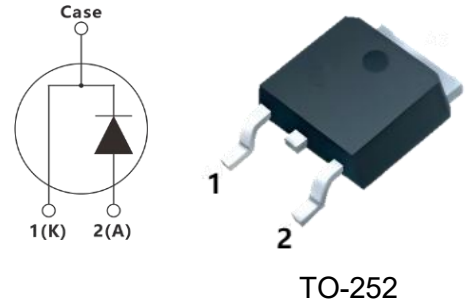

Features

- Zero reverse recovery current
- Zero forward recovery voltage
- Temperature independent switching behavior
- High temperature operation
- High frequency operation

Applications

- Fast charging
- Switched-Mode Power Supply
- Power Factor Correction
- LED lighting driver

Maximum Ratings (at $T_J=25^\circ\text{C}$ unless otherwise specified)

Parameter	Symbol	Value	Unit
Repetitive Peak Reverse Voltage	V_{RRM}	1200	V
Surge Peak Reverse Voltage	V_{RSM}	1200	V
Continuous Forward Current $T_C = 25^\circ\text{C}$ $T_C = 135^\circ\text{C}$ $T_C = 155^\circ\text{C}$	I_F	25.4 12.1 8	A
Repetitive Peak Forward Surge Current $T_C = 25^\circ\text{C}$, $t_p = 10\text{ms}$, Half Sine Pulse, $D=0.1$, 1000Cycle	I_{FRM}	40	A
Non-Repetitive Forward Surge Current $T_C = 25^\circ\text{C}$, $t_p = 10\text{ms}$, Half Sine Pulse	I_{FSM}	96	A
i^2t Value $T_C = 25^\circ\text{C}$, $t_p = 10\text{ms}$, Half Sine Pulse	$\int i^2 dt$	46	A^2s
Power dissipation $T_C = 25^\circ\text{C}$ $T_C = 110^\circ\text{C}$	P_{tot}	119 52	W
Operating junction Range	T_J	-55 to +175	$^\circ\text{C}$
Storage temperature Range	T_{stg}	-55 to +175	$^\circ\text{C}$

Thermal Characteristics

Parameter	Symbol	Typ.	Unit
Thermal resistance, junction – case.	R_{thJC}	1.26	$^{\circ}C/W$

Electrical Characteristics(at $T_J=25^{\circ}C$ unless otherwise specified)

Parameter	Symbol	Test Conditions	Min	Typ	Max	Unit
DC Blocking Voltage	V_{DC}		1200			V
Instantaneous forward voltage per leg	V_F	$I_F = 8A$ $T_J = 25^{\circ}C$ $T_J = 175^{\circ}C$		1.45 1.99	1.7 2.5	V
Reverse current per leg	I_R	$V_R = 1200V$ $T_J = 25^{\circ}C$ $T_J = 175^{\circ}C$		3.5 17	50 100	μA
Total Capacitance	C	$f = 1MHz$ $V_R = 0V$ $V_R = 400V$ $V_R = 800V$		595 38 30		pF
Total Capacitive Charge	Q_C	$V_R = 800V$ $T_J = 25^{\circ}C$		38		nC
Capacitance Stored Energy	E_C	$V_R = 800V$		20		μJ

Typical Characteristics

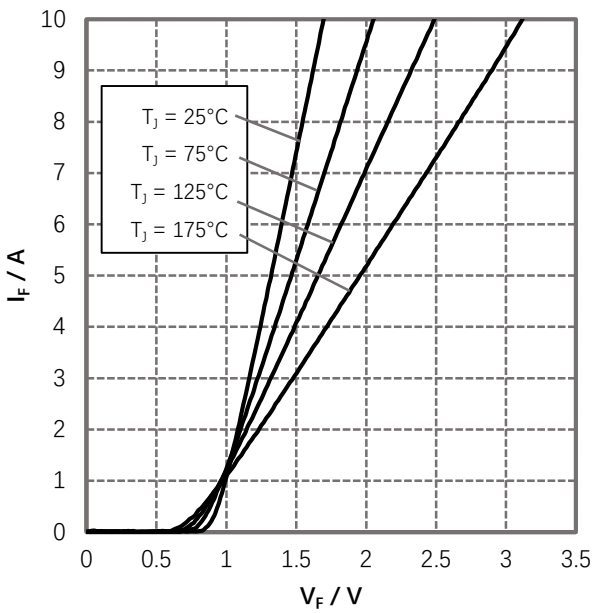

Figure 1. Forward Characteristics

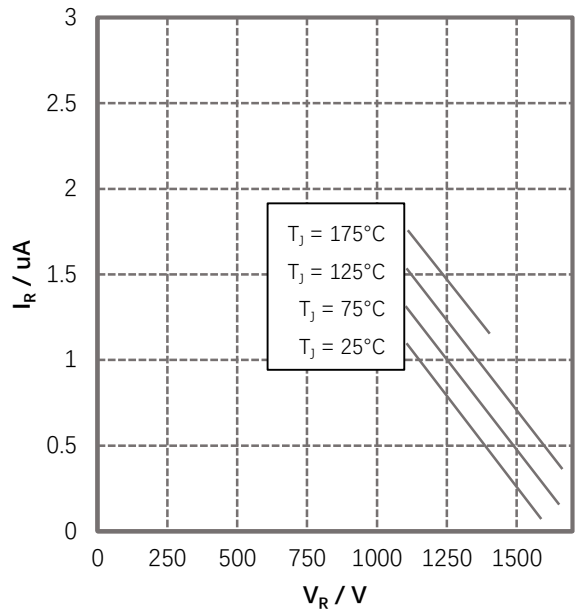

Figure 2. Reverse Characteristics

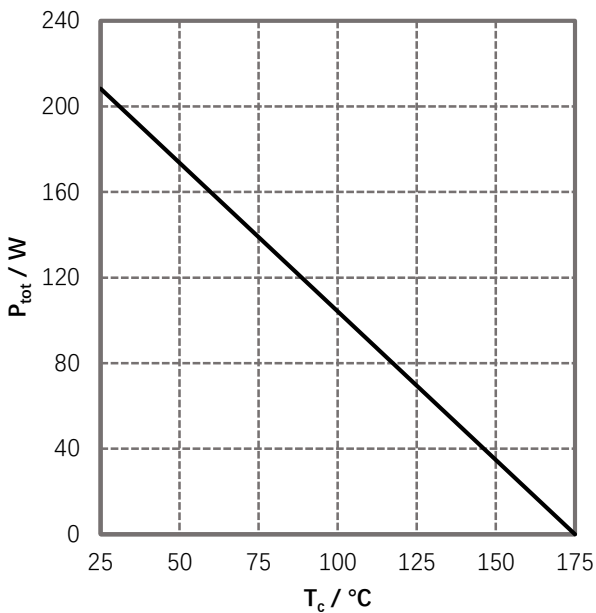

Figure 3. Power Derating

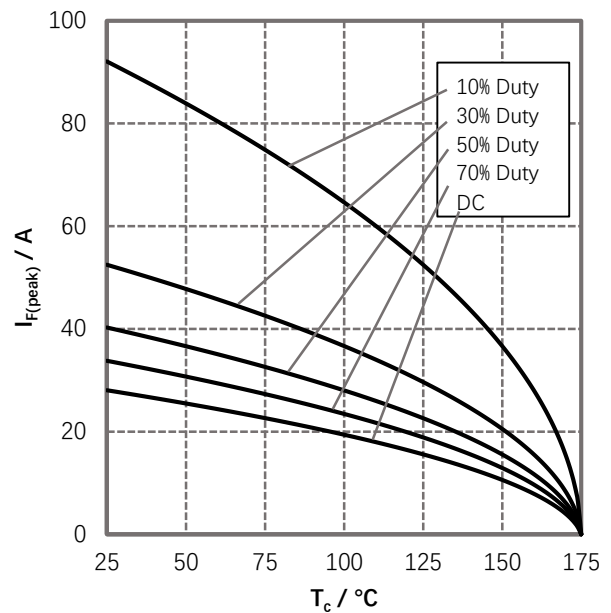

Figure 4. Current Derating

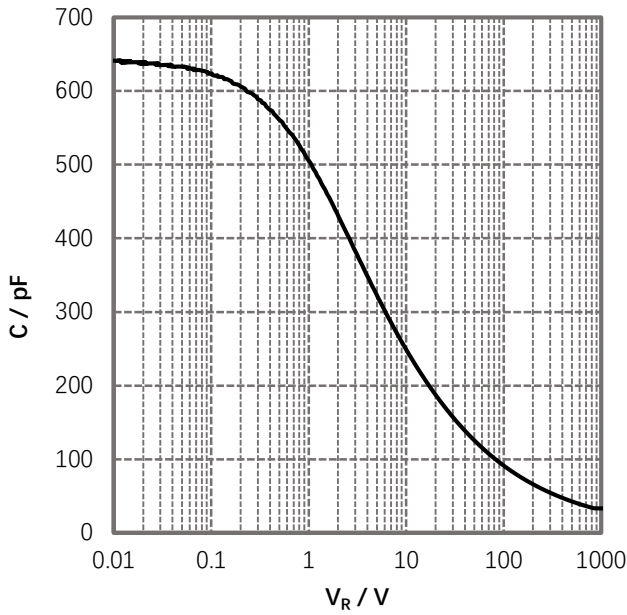

Figure 5. Capacitance vs. Reverse Voltage

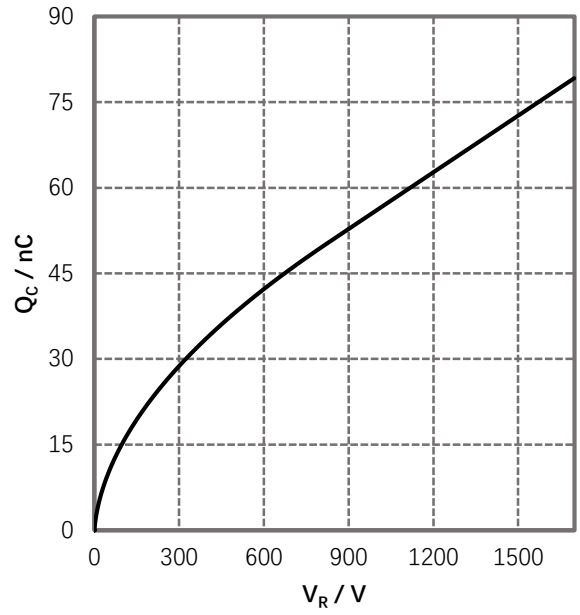

Figure 6. Reverse Charge vs. Reverse Voltage

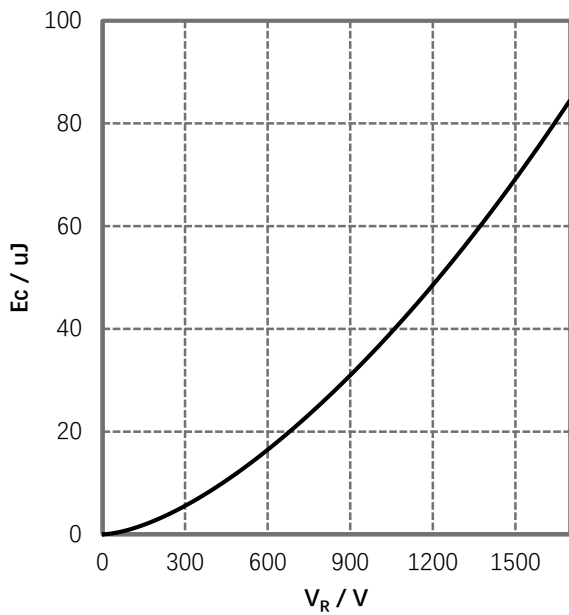

Figure 7. Capacitance Stored Energy

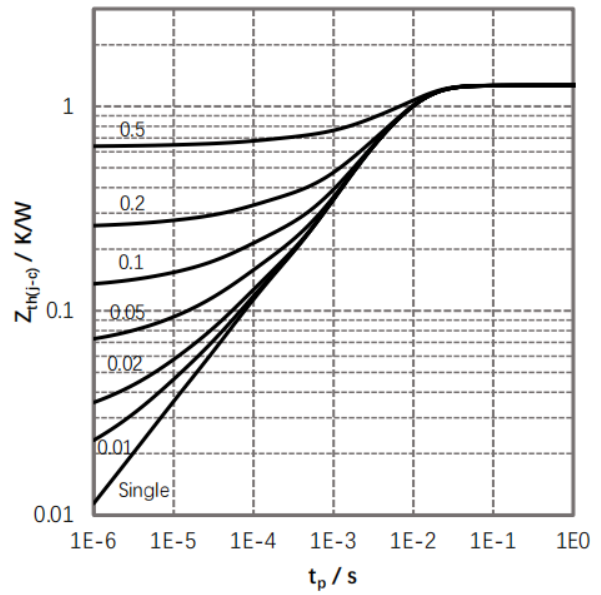
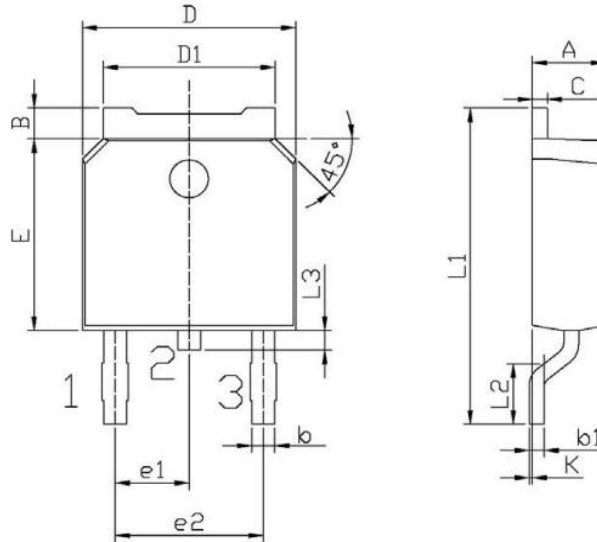

Figure 8. Transient Thermal Impedance

Package Outlines(Unit:mm)

TO-252

Unit: mm



Symbol	Dimensions In Millimeters		Symbol	Dimensions In Millimeters	
	Min	Max		Min	Max
A	2.20	2.40	E	5.95	6.25
B	0.95	1.25	e1	2.24	2.34
b	0.70	0.90	e2	4.43	4.73
b1	0.45	0.55	L1	9.85	10.35
C	0.45	0.55	L2	1.25	1.75
D	6.45	6.75	L3	0.60	0.90
D1	5.20	5.40	K	0.00	0.10

***Important Usage Information and Disclaimer**

The specifications of Zhuhai Hypersemi Co., Ltd. products are not guarantees of product characteristics. They reflect typical performance expected in standard applications, which may vary with specific uses. Users must conduct prior testing for their applications and make necessary adjustments.

Users are responsible for the safety of applications utilizing our products and must implement adequate safety measures to prevent physical injury, fire, or other risks in case of product failure. It is the user's duty to ensure that application designs comply with all applicable laws and standards. Our products must not be used in any applications where a product failure could reasonably result in personal injury, unless specifically authorized in a signed document by Zhuhai Hypersemi Co., Ltd.

No representations or warranties are made regarding the accuracy or completeness of this information, including any claims of non-infringement of third-party intellectual property rights. Zhuhai Hypersemi Co., Ltd. assumes no liability for any applications or uses of its products and does not grant any licenses to its intellectual property rights or those of others. We also make no claims regarding non-infringement of third-party intellectual property rights that may arise from applications.

Due to technical requirements, our products may contain hazardous substances. For details, please contact your nearest sales office. This document replaces all previous information and may be updated. We reserve the right to make changes.