

Silicon Carbide Schottky Diode

Parameter	Value	Unit
V_{RRM}	1200	V
I_F	30	A
Q_C	159	nC

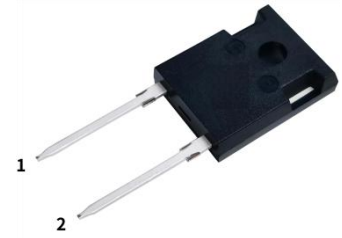
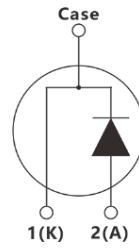

TO-247-2L

Features

- Zero reverse recovery current
- Zero forward recovery voltage
- Temperature independent switching behavior
- High temperature operation
- High frequency operation

Applications

- Switched-Mode Power Supply
- Power Factor Correction
- Uninterruptible Power Supply
- Boost Converter

Maximum Ratings (at $T_J=25^\circ\text{C}$ unless otherwise specified)

Parameter	Symbol	Value	Unit
Repetitive Peak Reverse Voltage	V_{RRM}	1200	V
Surge Peak Reverse Voltage	V_{RSM}	1200	V
Continuous Forward Current $T_C=25^\circ\text{C}$ $T_C=150^\circ\text{C}$	I_F	84 30	A
Non-Repetitive Forward Surge Current $T_C = 25^\circ\text{C}, t_p=10\text{ms}, \text{Half Sine Pulse}$	I_{FSM}	225	A
Power dissipation $T_C = 25^\circ\text{C}, T_J = 175^\circ\text{C}$	P_{tot}	312	W
Operating junction Range	T_J	-55 to +175	$^\circ\text{C}$
Storage temperature Range	T_{stg}	-55 to +175	$^\circ\text{C}$

Thermal Characteristics

Parameter	Symbol	Typ.	Unit
Thermal resistance, junction – case.	R_{thJC}	0.48	$^{\circ}C/W$

Electrical Characteristics (at $T_J=25^{\circ}C$ unless otherwise specified)

Parameter	Symbol	Test conditions	Value			Unit
			Min.	Typ.	Max.	
DC blocking voltage	V_{DC}		1200			V
Diode forward voltage	V_F	$I_F=30A, T_J=25^{\circ}C$ $I_F=30A, T_J=175^{\circ}C$		1.45 1.88	1.61	V
Reverse current	I_R	$V_R=1200V, T_J=25^{\circ}C$ $V_R=1200V, T_J=175^{\circ}C$			50 200	μA
Total capacitive charge	Q_C	$V_R=1000V, T_J=25^{\circ}C$		159		nC
Total capacitance	C	$T_J=25^{\circ}C$ $V_R=1V, f=1MHz$ $V_R=400V, f=1MHz$ $V_R=800V, f=1MHz$		2490 125 93		pF

Typical Characteristics

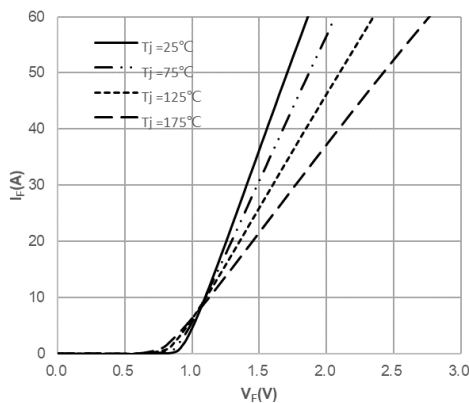

Fig1. Forward Characteristics

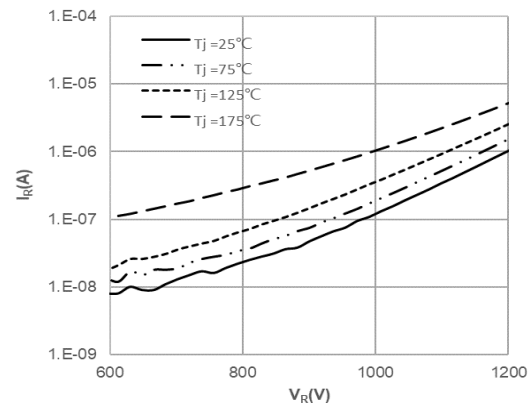

Fig2. Reverse Characteristics

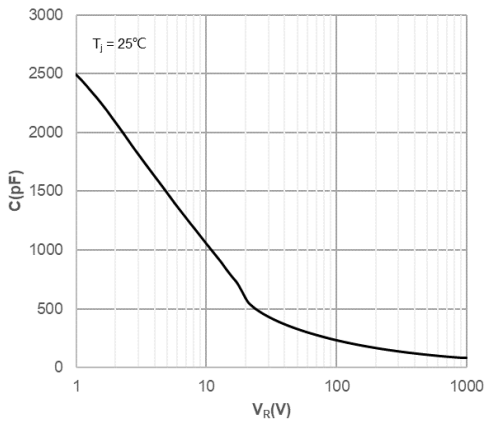

Fig3. Capacitance vs. Reverse Voltage

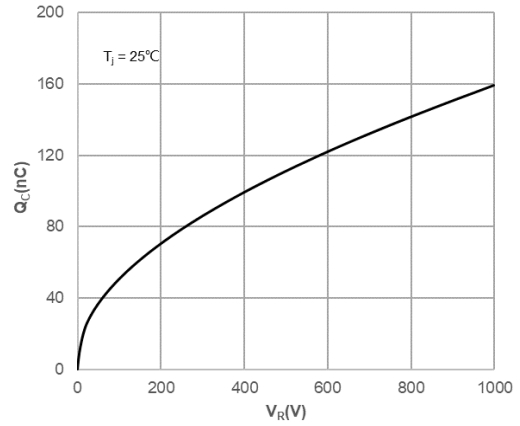
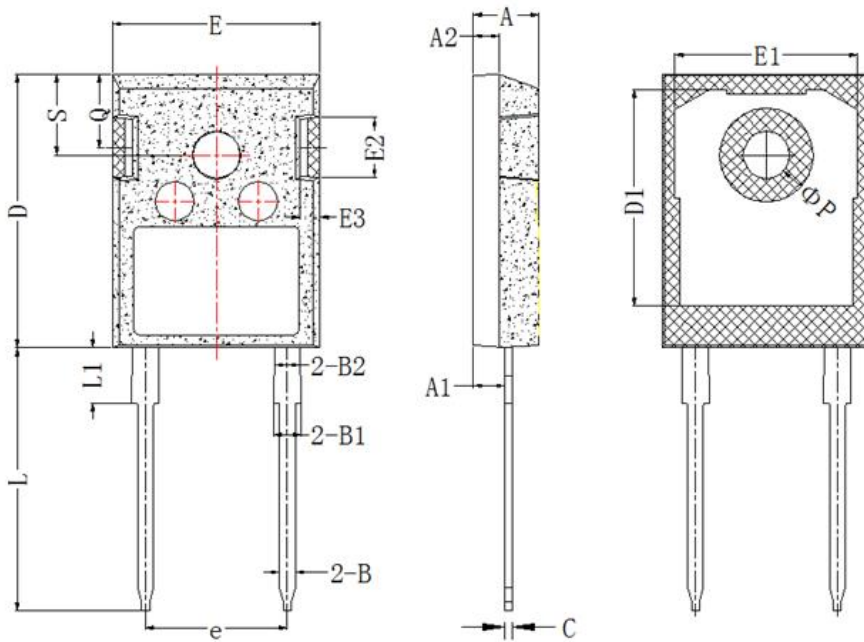

Fig4. Recovery Charge vs. Reverse Voltage

Package Outlines(Unit:mm)

TO-247-2L



Items	Values(mm)	
	MIN	MAX
A	4.85	5.15
A1	2.25	2.55
A2	1.85	2.15
B	1.04	1.33
B1	1.90	2.35
B2	1.90	2.15
C	0.55	0.68
D	20.80	21.10
D1	16.25	17.65
D2	0.95	1.35
E	15.70	16.10
E1	13.50	14.20
E2	3.80	5.00
E3	1.00	2.60
e	10.63	11.13
L	19.80	20.30
L1	4.00	4.50
φP	3.50	3.70
Q	5.40	6.00
S	6.00	6.40

***Important Usage Information and Disclaimer**

The specifications of Zhuhai Hypersemi Co., Ltd. products are not guarantees of product characteristics. They reflect typical performance expected in standard applications, which may vary with specific uses. Users must conduct prior testing for their applications and make necessary adjustments.

Users are responsible for the safety of applications utilizing our products and must implement adequate safety measures to prevent physical injury, fire, or other risks in case of product failure. It is the user's duty to ensure that application designs comply with all applicable laws and standards. Our products must not be used in any applications where a product failure could reasonably result in personal injury, unless specifically authorized in a signed document by Zhuhai Hypersemi Co., Ltd.

No representations or warranties are made regarding the accuracy or completeness of this information, including any claims of non-infringement of third-party intellectual property rights. Zhuhai Hypersemi Co., Ltd. assumes no liability for any applications or uses of its products and does not grant any licenses to its intellectual property rights or those of others. We also make no claims regarding non-infringement of third-party intellectual property rights that may arise from applications.

Due to technical requirements, our products may contain hazardous substances. For details, please contact your nearest sales office. This document replaces all previous information and may be updated. We reserve the right to make changes.