

Fast Recovery Diode Module

Symbol	Value	Unit
V_R	1200	V
I_{FAV}	200	A

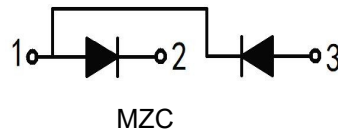

Features

- Ultra-Fast Reverse Recovery Time
- Soft Reverse Recovery Characteristics
- Low Reverse Recovery Loss
- High System Power Density

Applications

- Inversion Welder
- Power Factor Correction(PFC)Circuit
- Plating Power Supply
- Ultrasonic Cleaner And Welder
- Converter & Chopper

Maximum Ratings

Symbol	Item	Conditions	Values	Unit
V_R	Maximum D.C. Reverse Voltage	-	1200	V
V_{RRM}	Maximum Repetitive Reverse Voltage	-		
I_{FAV}	Average Forward Current	Rectangular, $d=0.5$, $T_c=78^\circ\text{C}$, Per Leg	200	A
		Rectangular, $d=0.5$, $T_c=78^\circ\text{C}$, Per Module	400	
I_{FRMS}	RMS Forward Current	$T_c=78^\circ\text{C}$, Per Leg	280	A
I_{FSM}	Non-Repetitive Peak Surge Current	$t=50\text{Hz}(10\text{ms})$, $V_R=0\text{V}$, Per Leg, $T_j=25^\circ\text{C}$	1800	A
I^2t	Circuit Fusing Consideration	$t=10\text{ms}$, $T_j=25^\circ\text{C}$	16200	A^2s
V_{ISO}	Isolation Breakdown Voltage	AC 50Hz/60Hz, R.M.S, 1min	3000	V
P_{tot}	Total Power Dissipation	$T_j=25^\circ\text{C}$	694	W
T_j	Operating Junction Temperature	-	-40 to +150	$^\circ\text{C}$
T_{stg}	Storage Temperature	-	-40 to +125	$^\circ\text{C}$
M_t	Mounting Torque	To Terminals(M6)	5±15%	N·m
M_s		To Heatsink(M6)	5±15%	
Weight	Module (Approximately)	-	185	g

Thermal Characteristics

Symbol	Item	Conditions	Values	Unit
$R_{th(j-c)}$	Thermal Impedance, Max	Junction to Case(Per Leg)	0.18	$^\circ\text{C}/\text{W}$

Electrical Characteristics

Symbol	Item	Conditions	Values			Unit
			Min.	Typ.	Max.	
V_{FM}	Forward Voltage Drop Per Leg, Max	$T_j=25^\circ\text{C}$, $I_F=200\text{A}$	-	-	2.5	V
I_{RRM}	Repetitive Peak Reverse Current Per Leg, Max	$T_j=25^\circ\text{C}$, $V_R=V_{RRM}$	-	-	0.2	mA
		$T_j=150^\circ\text{C}$, $V_R=V_{RRM}$	-	-	10	
t_{rr}	Typical Reverse Recovery Time Per Leg	$I_F=0.5\text{A}$, $I_R=-1\text{A}$, $I_{RR}=-0.25\text{A}$	-	110	-	ns
t_{rr}	Reverse Recovery Time	$I_F=200\text{A}$, $V_R=600\text{V}$, $di_F/dt=-200\text{A}/\mu\text{s}$, $T_j=25^\circ\text{C}$	-	200	-	ns
I_{RM}	Maximum Reverse Recovery Current		-	21	-	A
t_{rr}	Reverse Recovery Time	$I_F=200\text{A}$, $V_R=600\text{V}$, $di_F/dt=-200\text{A}/\mu\text{s}$, $T_j=125^\circ\text{C}$	-	340	-	ns
I_{RM}	Maximum Reverse Recovery Current		-	32	-	A
V_{T0}	Threshold Voltage, for power loss calculation only	$T_j=125^\circ\text{C}$	1.2			V
r_T	Slope Resistance, for power loss calculation only	$T_j=125^\circ\text{C}$	2.0			m Ω

Characteristics Diagram

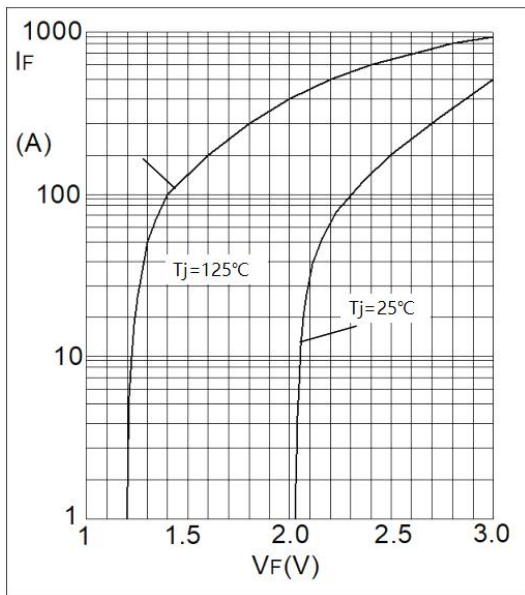

Fig1. Forward Characteristics

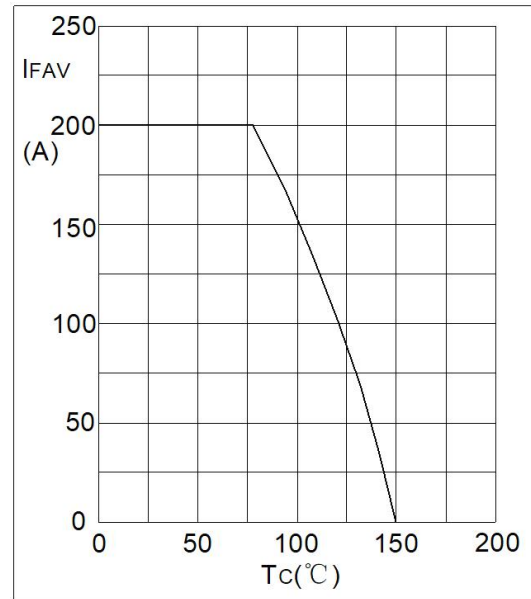

Fig2. Forward Current Derating Curve

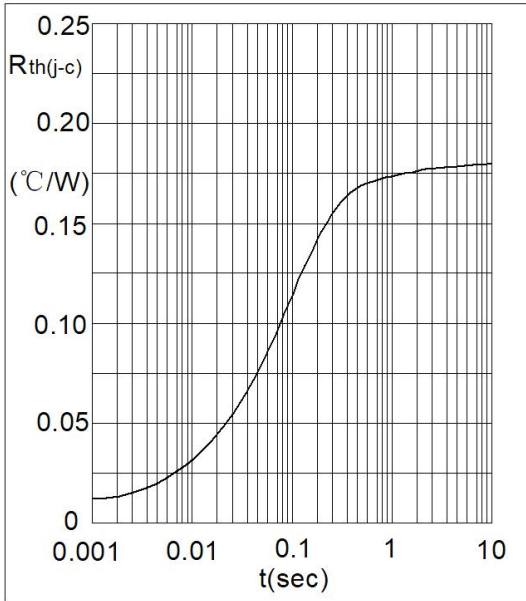

Fig3. Transient Thermal Impedance

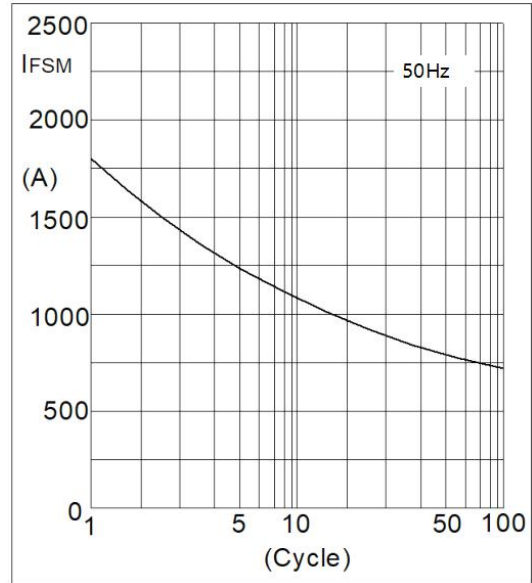

Fig4. Max Non-Repetitive Forward Surge Current

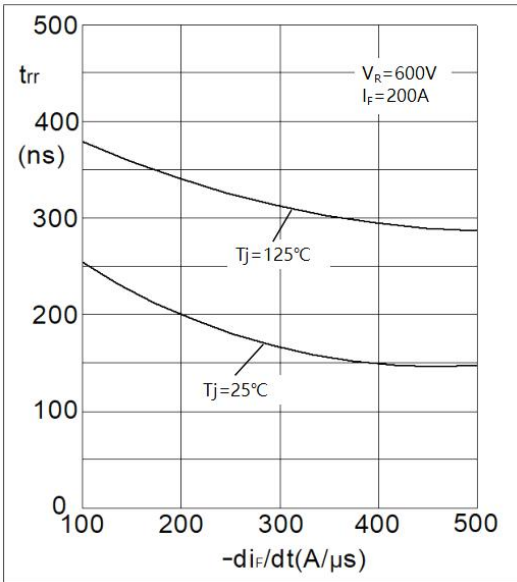

Fig5. Reverse Recovery Time VS di_F/dt

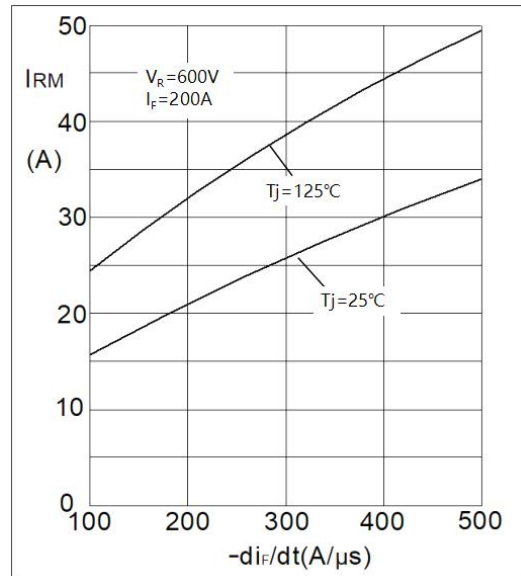

Fig6. Reverse Recovery Current VS di_F/dt

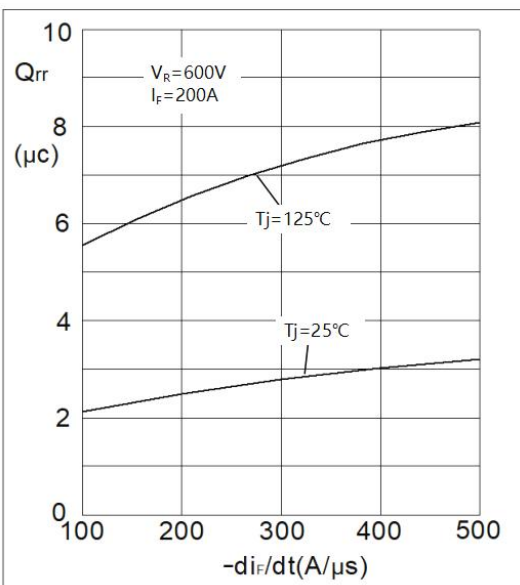
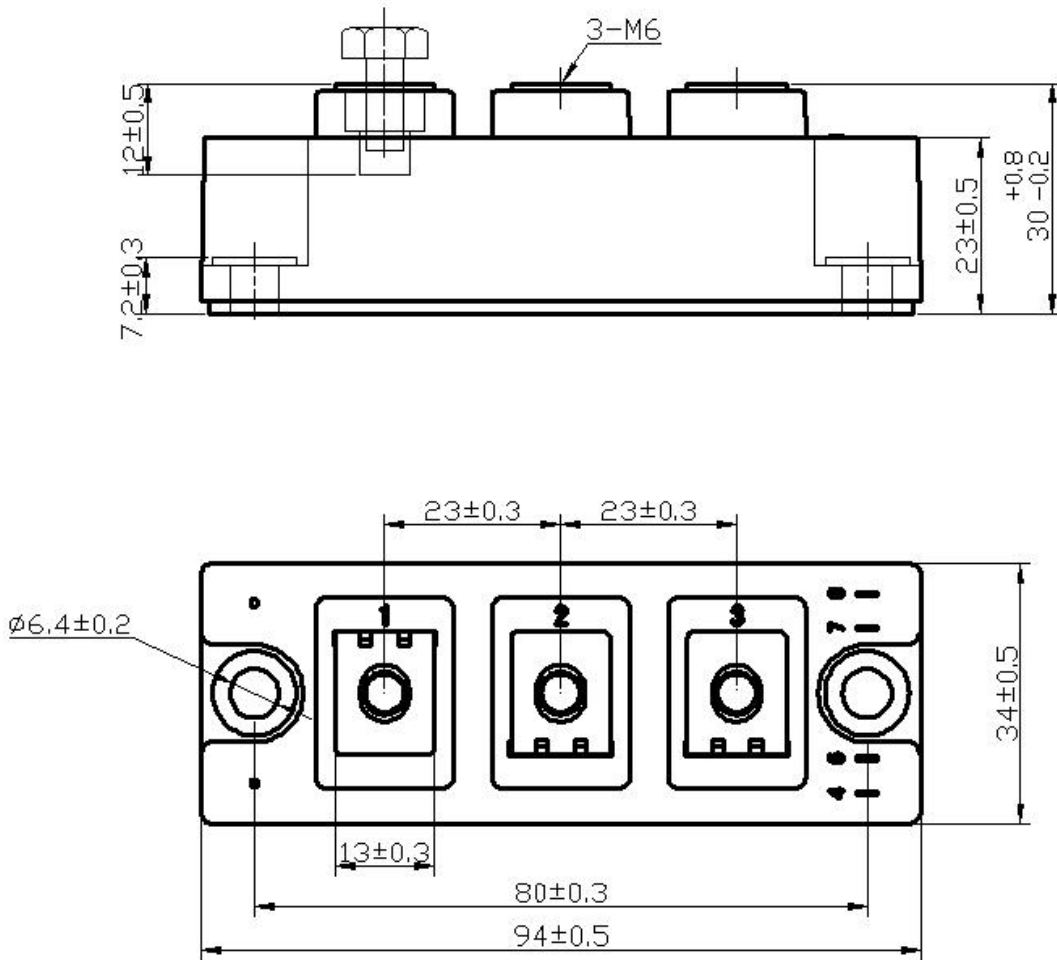

Fig7. Reverse Recovery Charge VS di_F/dt

Package Outlines M69GB (Dimensions in mm)



***Important Usage Information and Disclaimer**

The specifications of Zhuhai Hypersemi Co., Ltd. products are not guarantees of product characteristics. They reflect typical performance expected in standard applications, which may vary with specific uses. Users must conduct prior testing for their applications and make necessary adjustments.

Users are responsible for the safety of applications utilizing our products and must implement adequate safety measures to prevent physical injury, fire, or other risks in case of product failure. It is the user's duty to ensure that application designs comply with all applicable laws and standards. Our products must not be used in any applications where a product failure could reasonably result in personal injury, unless specifically authorized in a signed document by Zhuhai Hypersemi Co., Ltd.

No representations or warranties are made regarding the accuracy or completeness of this information, including any claims of non-infringement of third-party intellectual property rights. Zhuhai Hypersemi Co., Ltd. assumes no liability for any applications or uses of its products and does not grant any licenses to its intellectual property rights or those of others. We also make no claims regarding non-infringement of third-party intellectual property rights that may arise from applications.

Due to technical requirements, our products may contain hazardous substances. For details, please contact your nearest sales office. This document replaces all previous information and may be updated. We reserve the right to make changes.