

Ultrafast Recovery Rectifiers

Parameter	Value	Unit
V_{RRM}	200	V
$I_{F(AV)}$	16(2*8)	A

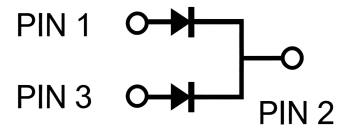

Features

- Low forward voltage drop
- High current capability
- High reliability
- High surge current capability

Applications

- Typical applications are in switching power supplies, converters, freewheeling diodes, and reverse battery protection.

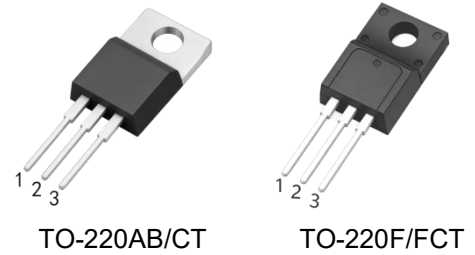

Absolute Maximum Ratings (Ta=25°C, unless otherwise noted)

Parameter		Symbol	Value	Unit
Maximum Repetitive Peak Reverse Voltage		V_{RRM}	200	V
Working Peak Reverse Voltage		V_{RWM}	200	V
Maximum DC Blocking Voltage		V_{DC}	200	V
Maximum Average Forward Rectified Current	Per Leg	$I_{F(AV)}$	8	A
	Total		16	
Peak Forward Surge Current, 8.3 ms Single Half Sine-wave Superimposed on Rated Load (JEDEC method)		I_{FSM}	160	A
Operating Temperature Range		T_J	150	°C
Storage Temperature Range		T_{STG}	-40 to +150	°C
Typical Thermal Resistance (Note1)		$R_{\theta JC}$	2	°C/W
TO-220AB, TO-263				
TO-220F				

Note1: Thermal resistance from Junction to case per leg mounted on heat sink.

Electrical Characteristics(Per Leg) unless otherwise specified

Parameter		Symbol	Value		Unit
Forward Voltage Drop(Note2)		V_F	Typ.	Max.	V
at $I_F=8A$	$T_A=25^\circ C$		0.93	0.97	
	$T_A=125^\circ C$		0.81	-	
Maximum Reverse Current at $V_R=200V$	$T_A=25^\circ C$	I_R	0.05	1	μA
	$T_A=125^\circ C$		5	-	μA
Maximum Reverse Recovery Time at $I_F=0.5A, I_R=1A$		T_{rr}	-	35	ns

Note2:Pulse test: 300 μs pulse width, 1% duty cycle

Typical Characteristics

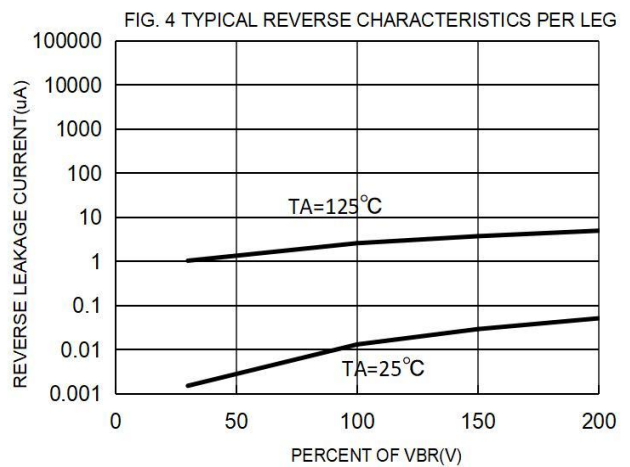
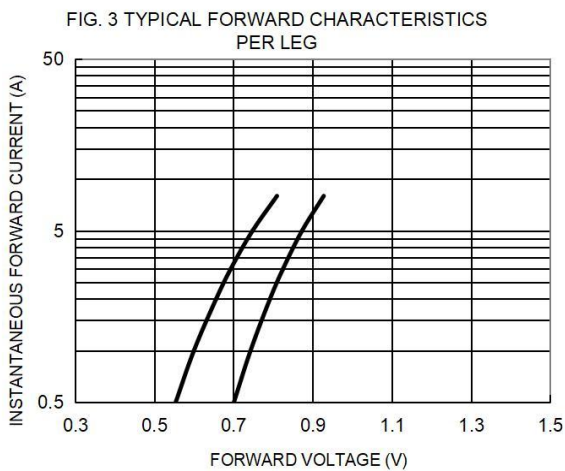
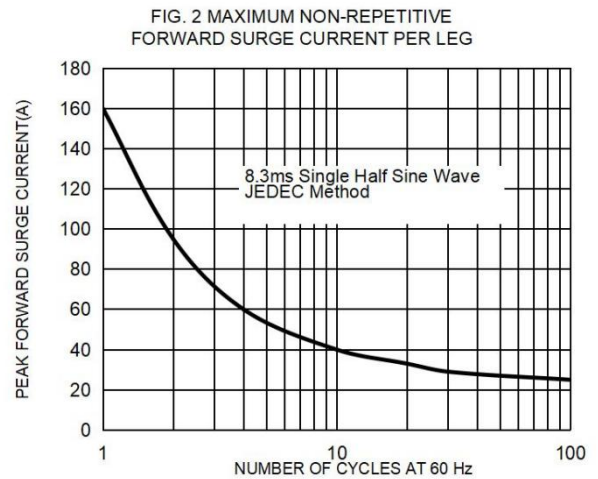
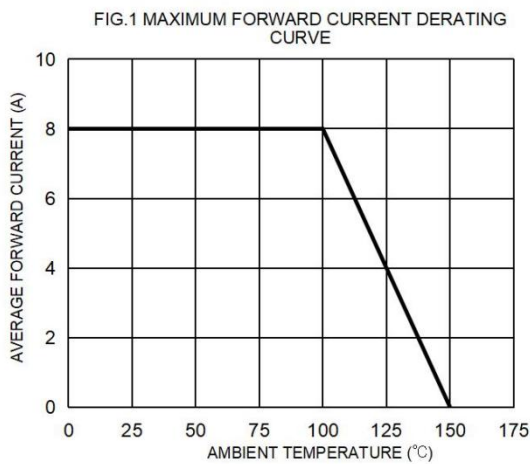

Package Outlines

TO-220AB

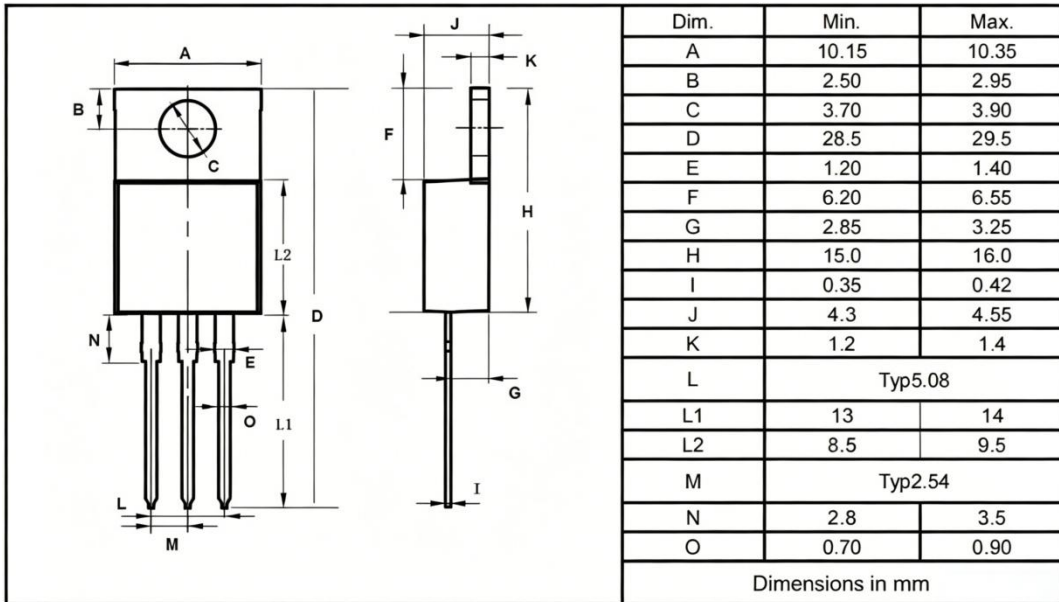

TO-220F

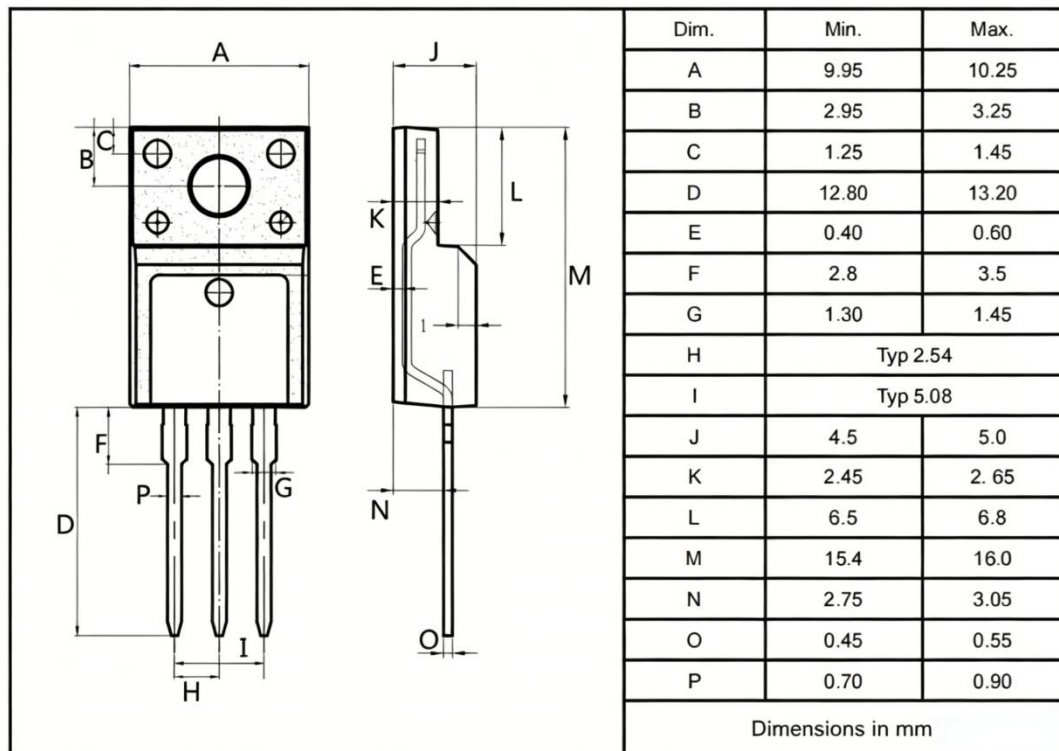

TO-263

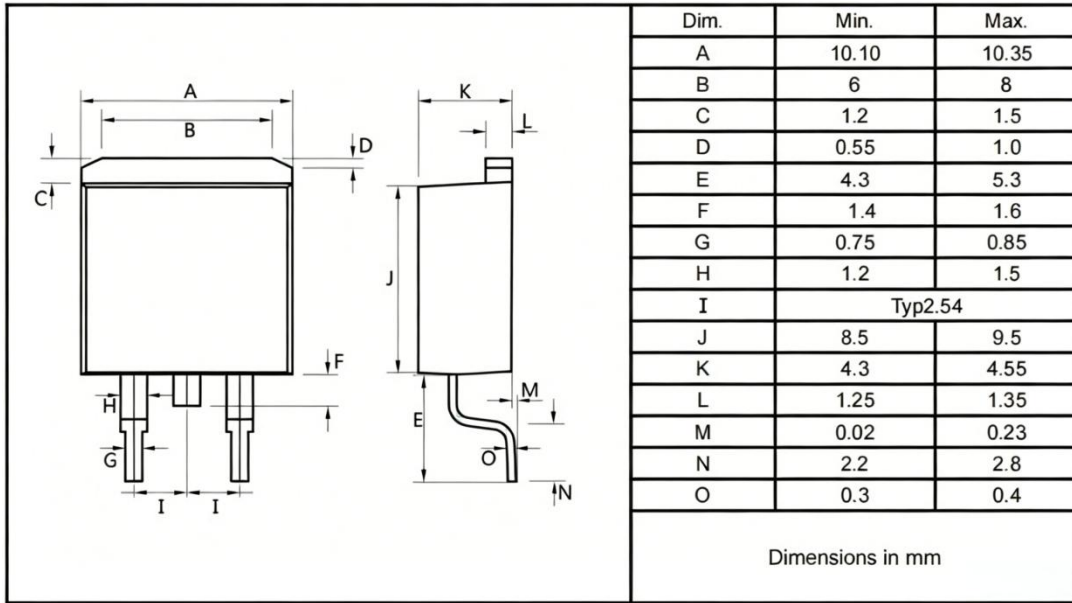

TO-252

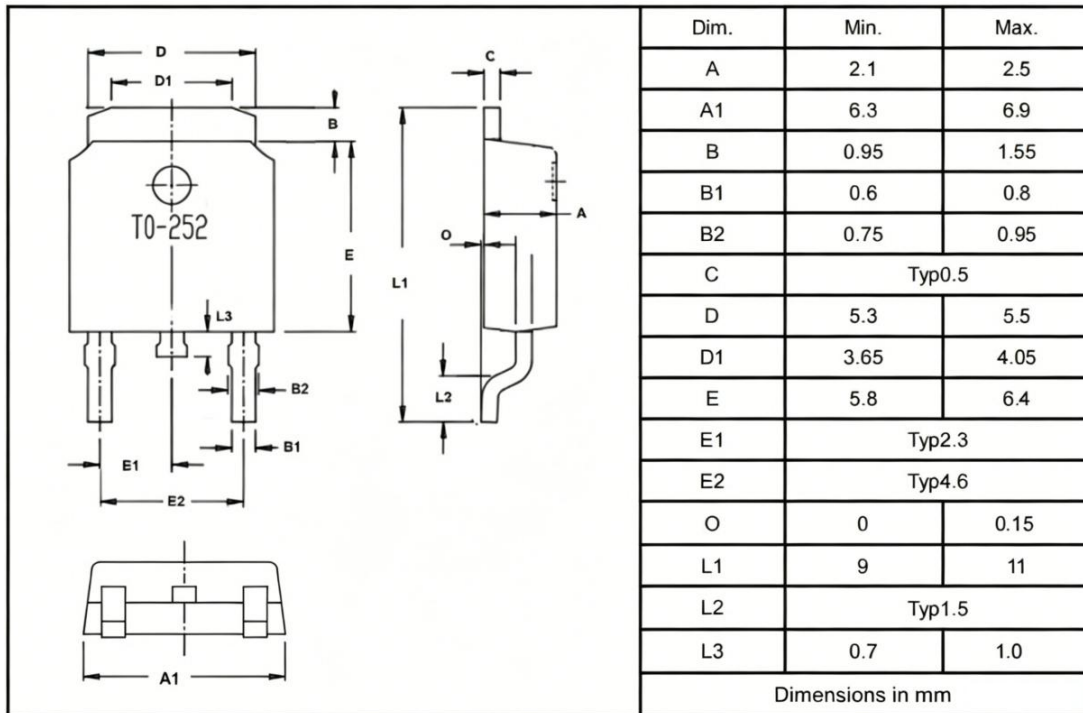

TO-251

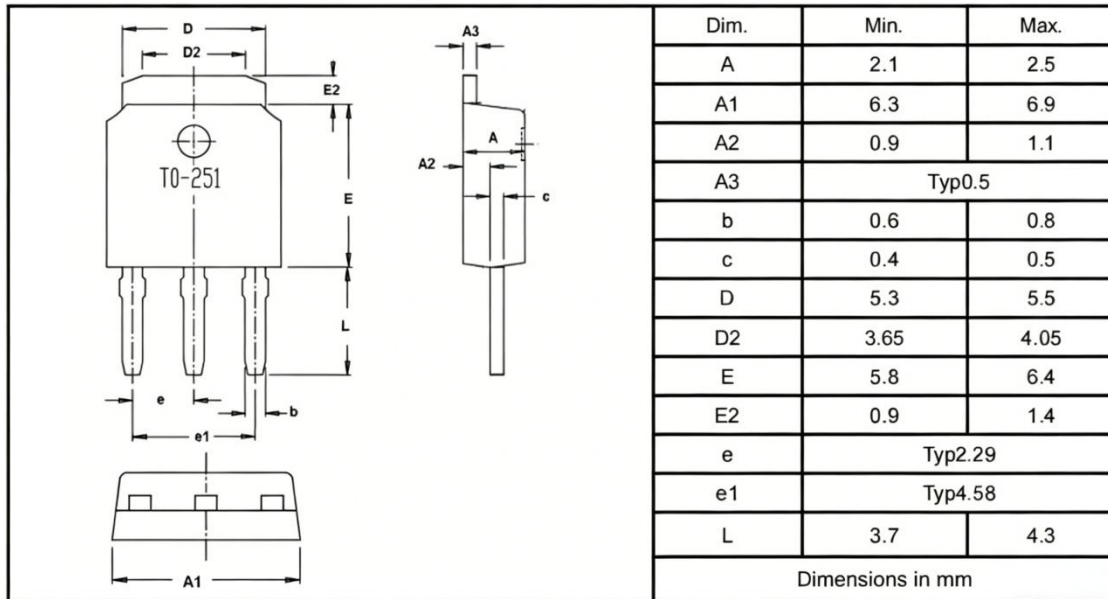

***Important Usage Information and Disclaimer**

The specifications of Zhuhai Hypersemi Co., Ltd. products are not guarantees of product characteristics. They reflect typical performance expected in standard applications, which may vary with specific uses. Users must conduct prior testing for their applications and make necessary adjustments.

Users are responsible for the safety of applications utilizing our products and must implement adequate safety measures to prevent physical injury, fire, or other risks in case of product failure. It is the user's duty to ensure that application designs comply with all applicable laws and standards. Our products must not be used in any applications where a product failure could reasonably result in personal injury, unless specifically authorized in a signed document by Zhuhai Hypersemi Co., Ltd.

No representations or warranties are made regarding the accuracy or completeness of this information, including any claims of non-infringement of third-party intellectual property rights. Zhuhai Hypersemi Co., Ltd. assumes no liability for any applications or uses of its products and does not grant any licenses to its intellectual property rights or those of others. We also make no claims regarding non-infringement of third-party intellectual property rights that may arise from applications.

Due to technical requirements, our products may contain hazardous substances. For details, please contact your nearest sales office. This document replaces all previous information and may be updated. We reserve the right to make changes.