

Three Phase Bridge Rectifier

Features

- Glass passivated chip
- Ideal for printed circuit boards
- High surge current capability
- Reverse Voltage : 800 to 1600V
- Forward Current : 35A
- High temperature soldering guaranteed:265°C/10 seconds



MT-GW

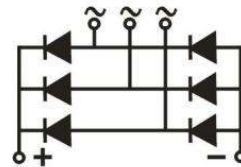

Applications

- Inverter for AC or DC motor control
- Current stabilized power supply
- Input rectifiers for variable frequency drives
- Input rectifiers for PWM inverter

Module Type

Type	VRRM	VRSM
MT3508GW	800V	900V
MT3510GW	1000V	1100V
MT3512GW	1200V	1300V
MT3516GW	1600V	1700V

Maximum Ratings

Item	Conditions	Symbol	Values	Unit
Output Current	Three Phase, Full Wave $T_c=78^\circ\text{C}$	I_b	35	A
Surge Forward Current	$T_j=25^\circ\text{C}$, $t=50\text{Hz}(10\text{ms})$, $V_R=0\text{V}$	I_{FSM}	400	A
Circuit Fusing Consideration	$t=10\text{ms}$ $T_j=25^\circ\text{C}$	I^2t	800	A^2s
Isolation Breakdown Voltage	AC 50Hz/60Hz; R.M.S; 1min	V_{iso}	2000	V
Operating Junction Temperature		T_j	-40 to +150	$^\circ\text{C}$
Storage Temperature		T_{stg}	-40 to +125	$^\circ\text{C}$
Mounting Torque	To Heatsink(M5)	M_s	2.5~3	N·m
Module (Approximately)		Weight	17	g

Thermal Characteristics

Item	Conditions	Symbol	Values	Unit
Thermal Impedance, Max	Junction to Case(Per Total)	$R_{th(j-c)}$	0.9	$^{\circ}C/W$
	Junction to Case(Per Diode)		5.4	$^{\circ}C/W$

Electrical Characteristics

Item	Conditions	Symbol	Values			Unit
			Min	Typ	Max	
Forward Voltage Drop, Max	$T_j = 25^{\circ}C, I_F = 17.5A$	V_{FM}	-	-	1.18	V
Repetitive Peak Reverse Current, Max	$T_j = 25^{\circ}C, V_R = V_{RRM}$	I_{RRM}	-	-	5	μA
	$T_j = 150^{\circ}C, V_R = V_{RRM}$		-	-	3	mA
Threshold Voltage, for power loss calculation only	$T_j = 125^{\circ}C$	V_{T0}	0.75			V
Slope Resistance, for power loss calculation only	$T_j = 125^{\circ}C$	r_T	10			m Ω

Ratings and Characteristic Curves ($T_A=25^{\circ}\text{C}$ unless otherwise noted)

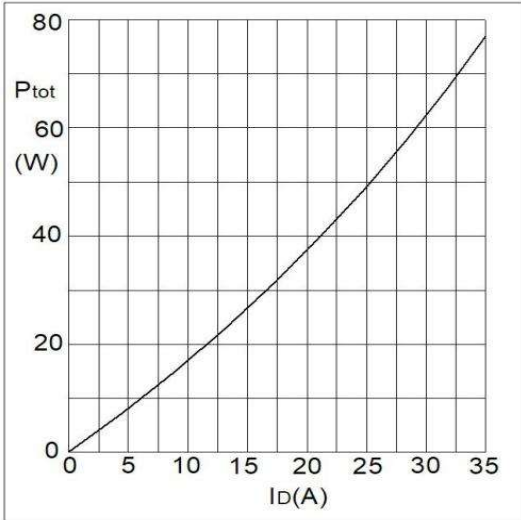

Fig1. Power Dissipation

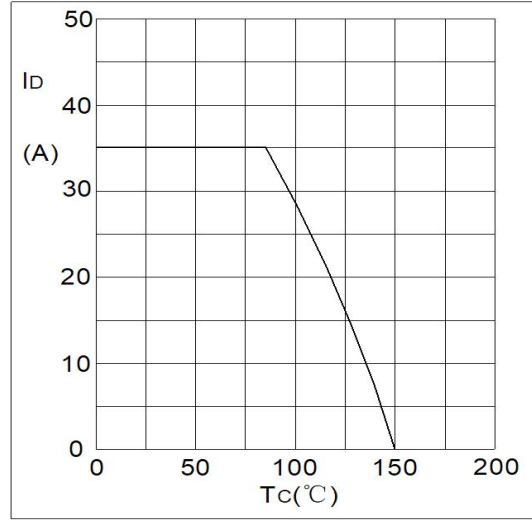

Fig2. Forward Current Derating Curve

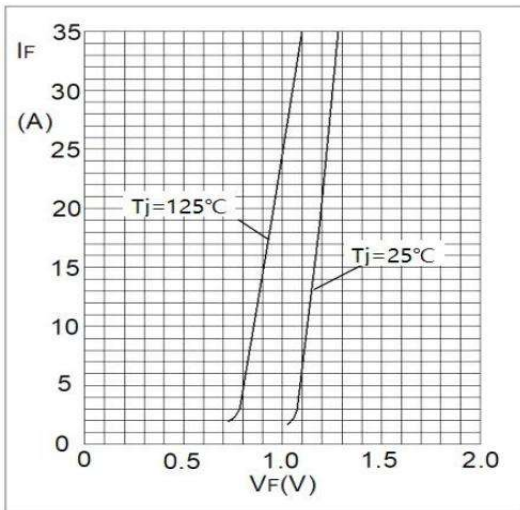

Fig3. Forward Characteristics

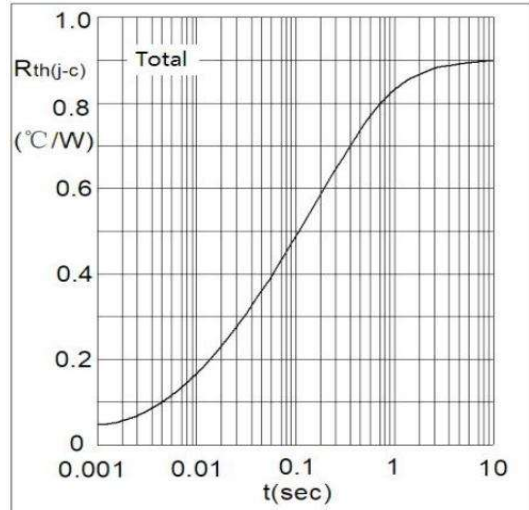

Fig4. Transient Thermal Impedance

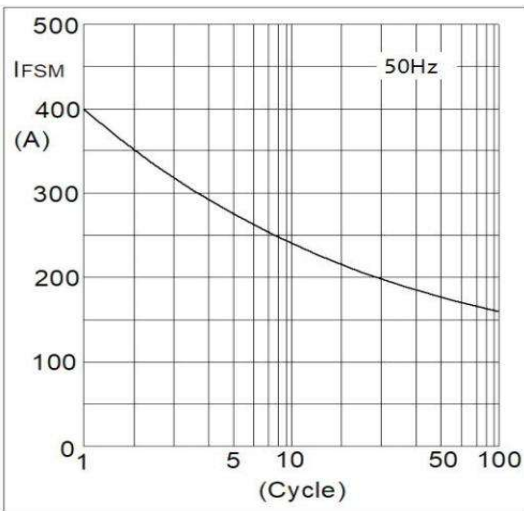
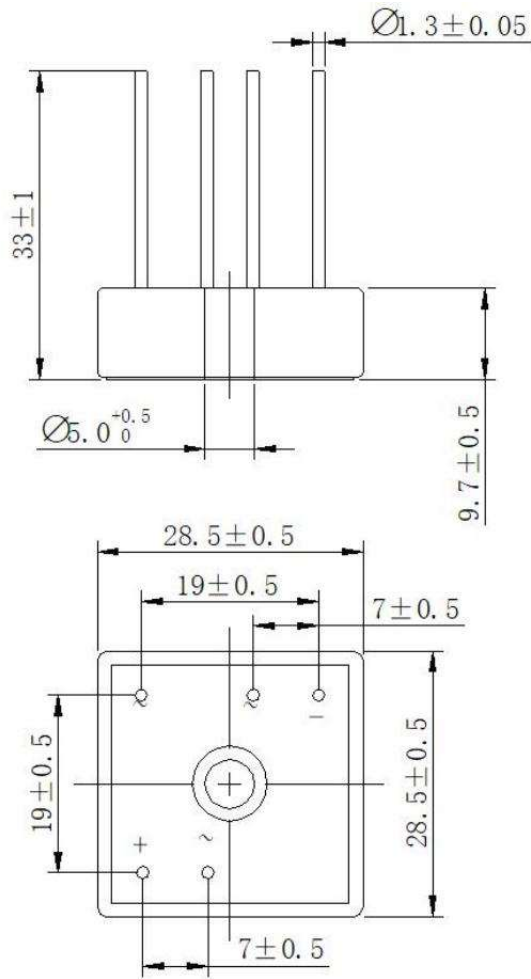

Fig5. Max Non-Repetitive Forward Surge Current

Package Outlines (Dimensions in mm)

Plastic surface mounted package(MT-GW)



***Important Usage Information and Disclaimer**

The specifications of Zhuhai Hypersemi Co., Ltd. products are not guarantees of product characteristics. They reflect typical performance expected in standard applications, which may vary with specific uses. Users must conduct prior testing for their applications and make necessary adjustments.

Users are responsible for the safety of applications utilizing our products and must implement adequate safety measures to prevent physical injury, fire, or other risks in case of product failure. It is the user's duty to ensure that application designs comply with all applicable laws and standards. Our products must not be used in any applications where a product failure could reasonably result in personal injury, unless specifically authorized in a signed document by Zhuhai Hypersemi Co., Ltd.

No representations or warranties are made regarding the accuracy or completeness of this information, including any claims of non-infringement of third-party intellectual property rights. Zhuhai Hypersemi Co., Ltd. assumes no liability for any applications or uses of its products and does not grant any licenses to its intellectual property rights or those of others. We also make no claims regarding non-infringement of third-party intellectual property rights that may arise from applications.

Due to technical requirements, our products may contain hazardous substances. For details, please contact your nearest sales office. This document replaces all previous information and may be updated. We reserve the right to make changes.