

15A Single Phase Bridge Rectifier

Features

- Ideal for printed circuit boards
- High case dielectric strength
- Reverse Voltage : 50 to 1000V
- Forward Current : 15A
- High temperature soldering : 260°C/10s at terminals

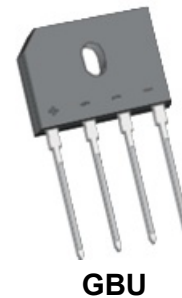

Applications

- General purpose use in AC/DC bridge full wave rectification for printer, power supply, switching mode power supply, adapter, and home appliances applications.

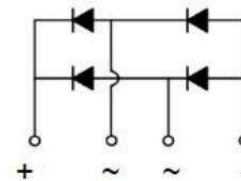

Maximum Ratings and Electrical characteristics

Ratings at 25 °C ambient temperature unless otherwise specified. Single phase half-wave 60 Hz, resistive or inductive load, for capacitive load current derate by 20 %.

Parameter	Symbol	GBU 15005	GBU 1501	GBU 1502	GBU 1504	GBU 1506	GBU 1508	GBU 1510	Unit
Maximum Repetitive Peak Reverse Voltage	V_{RRM}	50	100	200	400	600	800	1000	V
Maximum RMS Voltage	V_{RMS}	35	70	140	280	420	560	700	V
Maximum DC Blocking Voltage	V_{DC}	50	100	200	400	600	800	1000	V
Maximum Average Forward Rectified Current @ $T_C=100^{\circ}C$ with heatsink (Note 1)	$I_{F(AV)}$	15							A
Peak Forward Surge Current 8.3mS single half sine wave superimposed on rated load(JEDEC method)	I_{FSM}	220							A
Rating for fusing ($t < 8.3ms, T_j = 25^{\circ}C$)	I^2t	200							A ² s
Maximum Instantaneous Forward Voltage @7.5A	V_F	1.0							V
Maximum DC Reverse Current at Rated DC Blocking Voltage	$T_A=25^{\circ}C$	10							μA
	$T_A=125^{\circ}C$	500							
Typical Thermal Resistance (Note 1)	$R_{\theta JC}$	2.2							$^{\circ}C/W$
Operating Junction and Storage Temperature Range	T_J, T_{STG}	(-55 to +150)							$^{\circ}C$

Notes:

1. Device mounted on 75mm*75mm*1.6mm Al plate heatsink.

Ratings and Characteristic Curves ($T_A=25^\circ\text{C}$ unless otherwise noted)

FIG.1 - Typical forward current derating curve

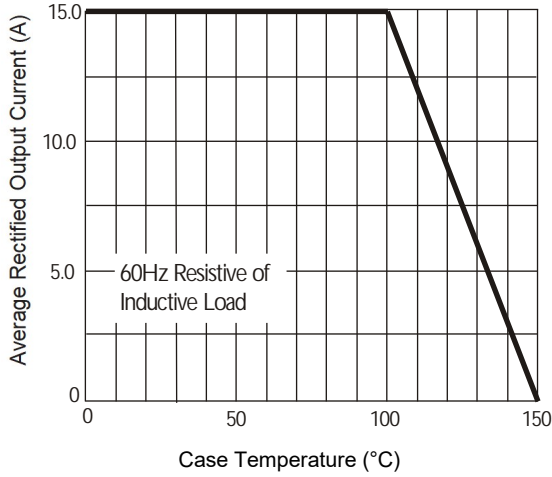

FIG.2 - Maximum Non-Repetitive Peak Forward Surge Current

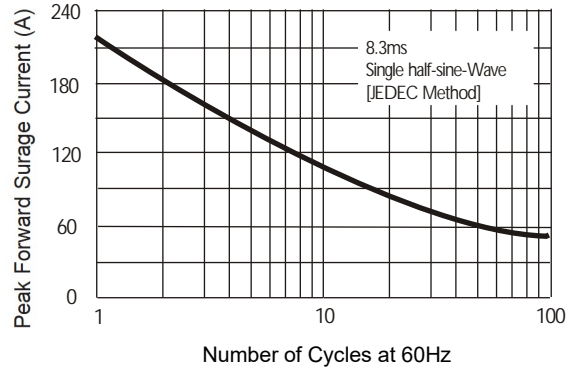

FIG.3 - Typical Junction Capacitance

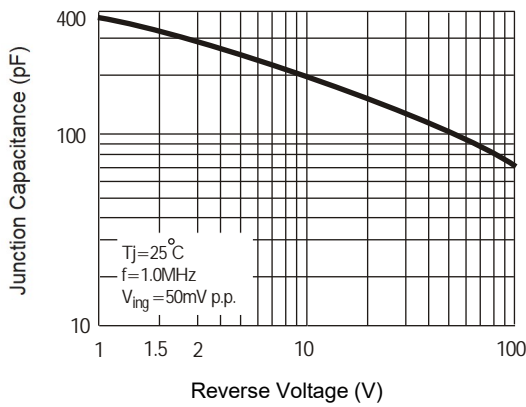

FIG.4 - Typical Instantaneous Forward Characteristics

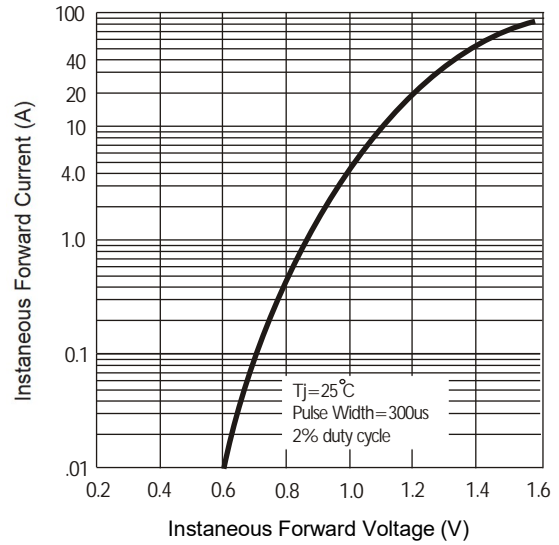
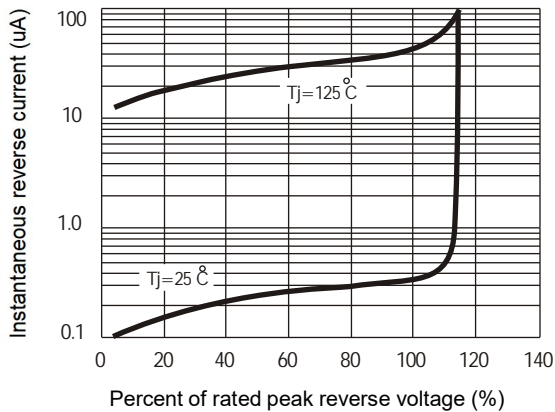
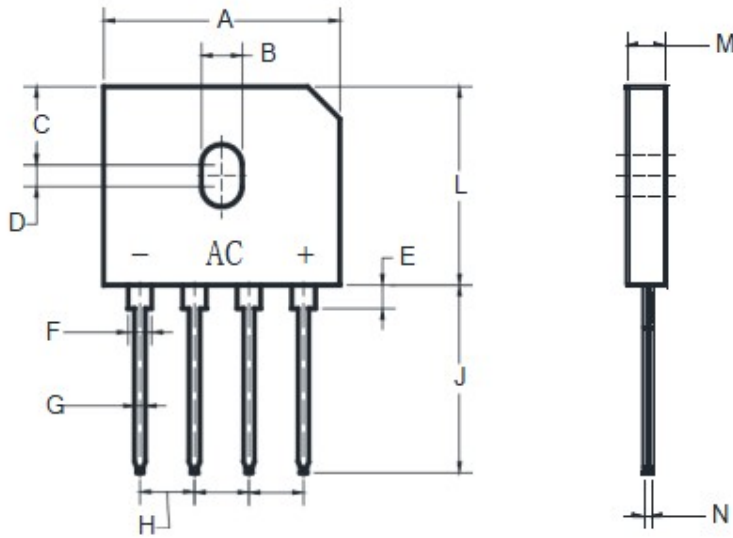

FIG.5 - Typical reverse Characteristics



Package Outlines (Dimensions in mm)

Plastic surface mounted package(GBU)



GBU		
Dim	Min	Max
A	21.70	22.50
B	3.40	4.10
C	7.40	8.00
D	1.65	2.26
E	2.25	2.85
F	2.05	2.4
G	1.02	1.37
H	4.83	5.43
J	17.0	18.6
L	18.3	18.9
M	3.30	3.66
N	0.46	0.66

Dimensions in millimeters

***Important Usage Information and Disclaimer**

The specifications of Zhuhai Hypersemi Co., Ltd. products are not guarantees of product characteristics. They reflect typical performance expected in standard applications, which may vary with specific uses. Users must conduct prior testing for their applications and make necessary adjustments.

Users are responsible for the safety of applications utilizing our products and must implement adequate safety measures to prevent physical injury, fire, or other risks in case of product failure. It is the user's duty to ensure that application designs comply with all applicable laws and standards. Our products must not be used in any applications where a product failure could reasonably result in personal injury, unless specifically authorized in a signed document by Zhuhai Hypersemi Co., Ltd.

No representations or warranties are made regarding the accuracy or completeness of this information, including any claims of non-infringement of third-party intellectual property rights. Zhuhai Hypersemi Co., Ltd. assumes no liability for any applications or uses of its products and does not grant any licenses to its intellectual property rights or those of others. We also make no claims regarding non-infringement of third-party intellectual property rights that may arise from applications.

Due to technical requirements, our products may contain hazardous substances. For details, please contact your nearest sales office. This document replaces all previous information and may be updated. We reserve the right to make changes.