

Single Phase Bridge Rectifier

Features

- Glass passivated chip
- Ideal for printed circuit boards
- High surge current capability
- Reverse Voltage : 200 to 1200V
- Forward Current : 15A
- High temperature soldering : 265 °C/10s at terminals



GBPC

Applications

- Single phase rectifiers for power supplies
- Rectifiers for DC motor field supplies
- Industrial automation equipment
- Input rectifiers for inverter

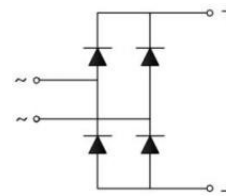

Module Type

Type	VRRM	VRSM
GBPC1502	200V	300V
GBPC1504	400V	500V
GBPC1506	600V	700V
GBPC1508	800V	900V
GBPC1510	1000V	1100V
GBPC1512	1200V	1300V

Maximum Ratings

Item	Conditions	Symbol	Values	Unit
Output Current	Single Phase, Sin Full Wave $T_c=100^\circ\text{C}$	I_D	15	A
Surge Forward Current	$T_j=25^\circ\text{C}$, $t=50\text{Hz}(10\text{ms})$, $V_R=0\text{V}$	I_{FSM}	300	A
Circuit Fusing Consideration	$t=10\text{ms}$ $T_j=25^\circ\text{C}$	I^2t	450	A^2s
Isolation Breakdown Voltage	AC 50Hz/60Hz; R.M.S; 1min	V_{ISO}	2000	V
Operating Junction Temperature		T_j	-40 to +150	$^\circ\text{C}$
Storage Temperature		T_{stg}	-40 to +125	$^\circ\text{C}$
Mounting Torque	To Heatsink(M5)	M_s	2.5~3	N·m
Module (Approximately)		Weight	14	g

Thermal Characteristics

Item	Conditions	Symbol	Values	Unit
Thermal Impedance, Max	Junction to Case(Per Total)	$R_{th(j-c)}$	1.6	$^{\circ}\text{C}/\text{W}$
	Junction to Case(Per Diode)		6.4	$^{\circ}\text{C}/\text{W}$

Electrical Characteristics

Item	Conditions	Symbol	Values			Unit
			Min	Typ	Max	
Forward Voltage Drop, Max	$T_j = 25^{\circ}\text{C}$, $I_F = 7.5\text{A}$	V_{FM}	-	-	1.1	V
Repetitive Peak Reverse Current, Max	$T_j = 25^{\circ}\text{C}$, $V_R = V_{RRM}$	I_{RRM}	-	-	5	μA
	$T_j = 150^{\circ}\text{C}$, $V_R = V_{RRM}$		-	-	0.5	mA
Threshold Voltage, for power loss calculation only	$T_j = 125^{\circ}\text{C}$	V_{T0}	0.75			V
Slope Resistance, for power loss calculation only	$T_j = 125^{\circ}\text{C}$	r_T	12.8			$\text{m}\Omega$

Ratings and Characteristic Curves ($T_A=25^{\circ}\text{C}$ unless otherwise noted)

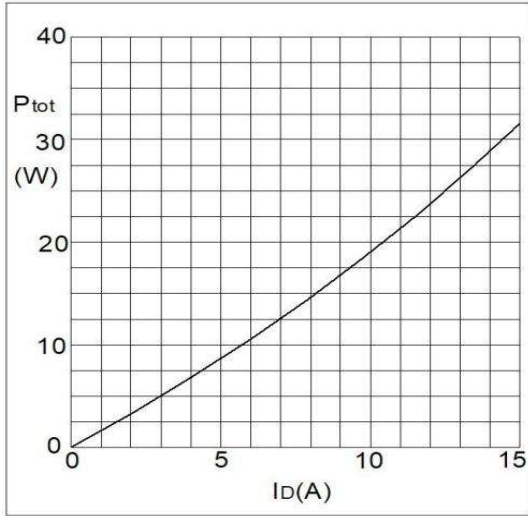

Fig1. Power Dissipation

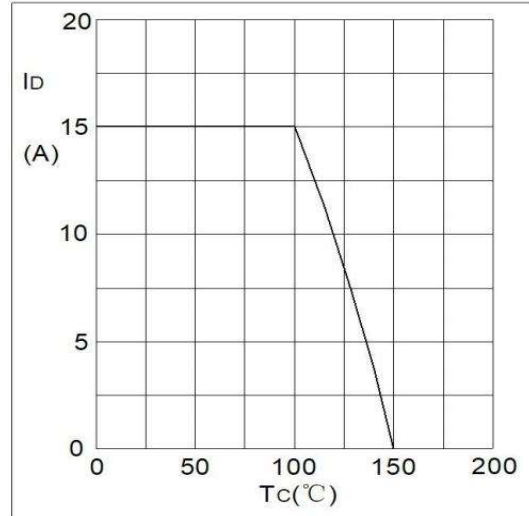

Fig2. Forward Current Derating Curve

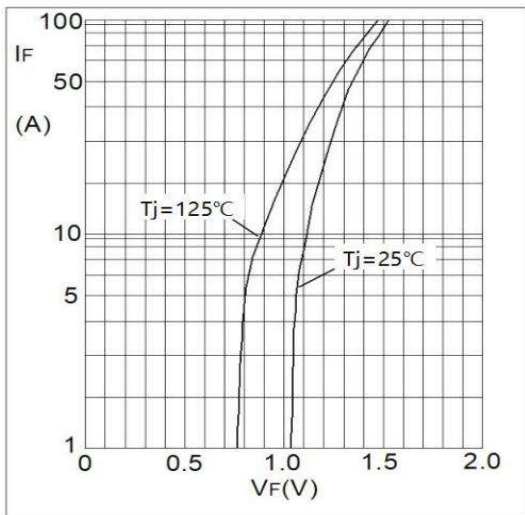

Fig3. Forward Characteristics

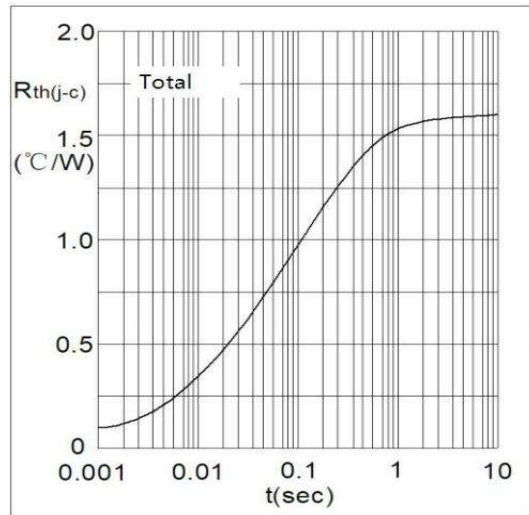

Fig4. Transient Thermal Impedance

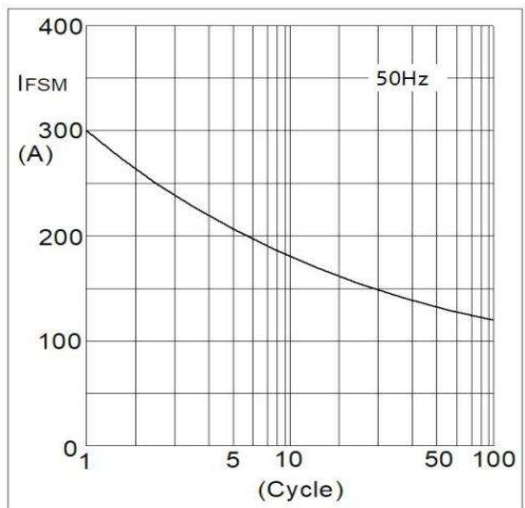
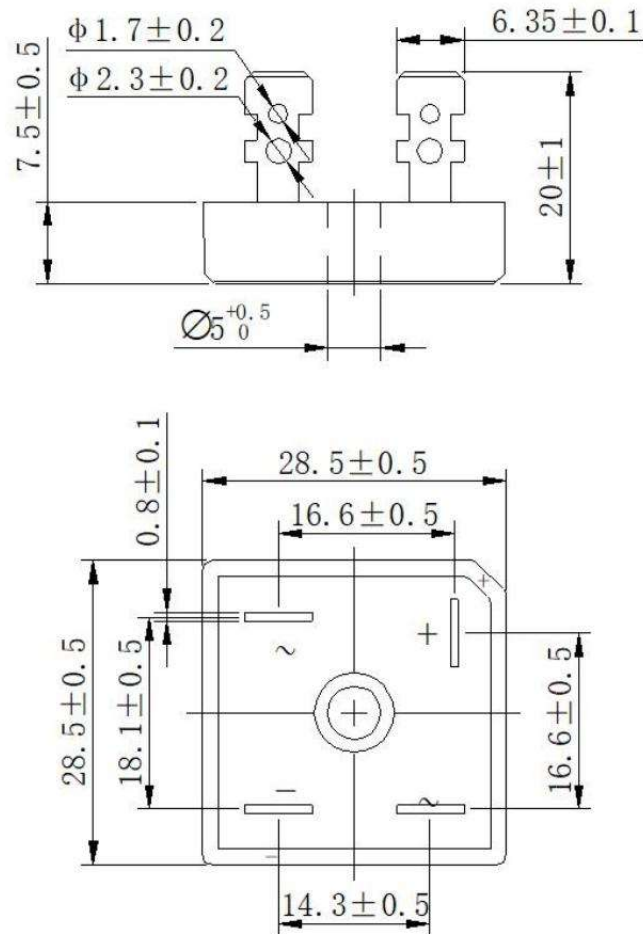

Fig5. Max Non-Repetitive Forward Surge Current

Package Outlines (Dimensions in mm)

Plastic surface mounted package(GBPC)



***Important Usage Information and Disclaimer**

The specifications of Zhuhai Hypersemi Co., Ltd. products are not guarantees of product characteristics. They reflect typical performance expected in standard applications, which may vary with specific uses. Users must conduct prior testing for their applications and make necessary adjustments.

Users are responsible for the safety of applications utilizing our products and must implement adequate safety measures to prevent physical injury, fire, or other risks in case of product failure. It is the user's duty to ensure that application designs comply with all applicable laws and standards. Our products must not be used in any applications where a product failure could reasonably result in personal injury, unless specifically authorized in a signed document by Zhuhai Hypersemi Co., Ltd.

No representations or warranties are made regarding the accuracy or completeness of this information, including any claims of non-infringement of third-party intellectual property rights. Zhuhai Hypersemi Co., Ltd. assumes no liability for any applications or uses of its products and does not grant any licenses to its intellectual property rights or those of others. We also make no claims regarding non-infringement of third-party intellectual property rights that may arise from applications.

Due to technical requirements, our products may contain hazardous substances. For details, please contact your nearest sales office. This document replaces all previous information and may be updated. We reserve the right to make changes.